

INDUSTRIAL FURNITURE

THE BEST CHOICE FOR:

WORKSHOP

GARAGE

AUTO-REPAIR SHOP

WAREHOUSE

FACTORIES AND PLANTS

Workbenches | Tool Cabinets | Tool Trolleys |
Shelving | Personal Lockers | Plan files



TABLE OF CONTENTS

4	Workbenches Profi W
6	Ready sets of workbenches Profi W
7	Perforated panels for workbenches Profi W
8	Options for workbenches Profi W
10	Workbenches Expert T
12	Reinforced workbenches Profi M
13	Options for workbenches Profi M
14	Ready sets of workbenches Profi M
16	Workbenches Master
18	Ready sets of workbenches Master
19	Options for workbenches Master
20	Workbenches Garage, Garage Set
21	Options for workbenches Garage
22	Tool trolleys Garage & Garage Big
24	Tool trolleys WDS
26	Tool trolleys WDS-x.0 NEW
27	Tool trolleys WDS-x.1 NEW
28	Additional options for workbenches and tool trolleys
30	Tool cabinet TC 1095
31	Ready sets of tool cabinets TC 1095
32	Tool cabinet TC 1995
33	Ready sets of tool cabinets TC 1995
34	Tool cabinet TC 1995/2
35	Ready sets of tool cabinets TC 1995/2
36	Tool cabinet TC 1947
37	Ready sets of tool cabinets TC 1947
38	Heavy duty tool cabinet AMH TC
39	Ready sets of heavy duty tool cabinets AMH TC
40	Heavy duty modular tool cabinets HARD 1000 & HARD 2000
41	Options of modular tool cabinet HARD
42	Ready sets of modular tool cabinets HARD 1000
43	Ready sets of modular tool cabinets HARD 2000
44	Tool storage solutions
47	Options for tool storage
48	Tool rack Profi
50	Drying cabinets Serie DC
51	Drying cabinet DC Cyclone 1965 /1985
52	Drying cabinet DC Breeze 1940
53	Drying rack North
54	Professional drying cabinet DC Sakhara 5 /8
57	Middle load shelving MS Pro
58	Options for shelving MS Pro
60	Ready sets of shelving MS Pro
62	Options for shelving MS
64	Shelving SB
65	Standart set SB options
66	Shelving SBL
67	Standart set SBL options
68	Reinforced individual lockers ML
70	Filling cabinets A1 и A0
71	Projects reference list
74	Useful information
76	CNC instrument holder information

ABOUT THE COMPANY

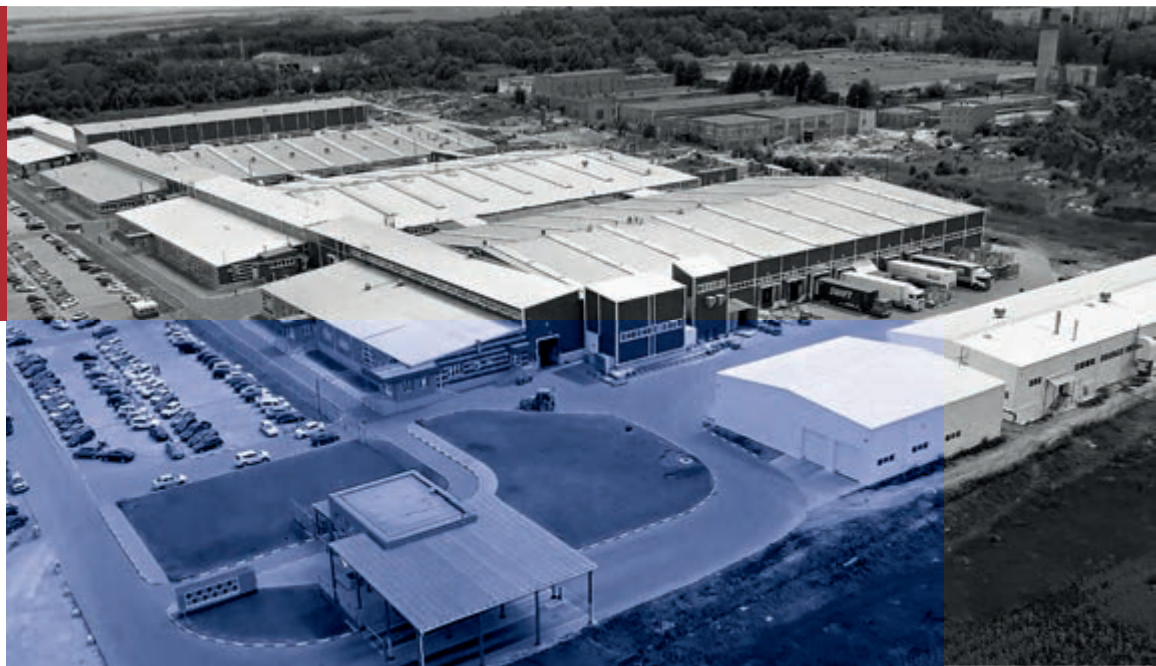

Group of companies Promet is one of the leading steel furniture and safe manufacturers. The Group has three factories including the main export plant located in the European Union, the Republic of Bulgaria



The factories are equipped with the most advanced metal processing equipment, which is not only sufficiently effective and suitable for production on a large scale, but also flexible and adjustable for manufacturing a wide range of items and switching quickly among various product types.



Quality management system corresponds and is certified according to international standard ISO9001, starting from September 2001 by DNV GL—one of the biggest and trustworthy international certifying body.



The manufacturing philosophy is based on the management principles of «lean manufacturing».

PROMET

1991 ■

THE COMPANY WAS FOUNDED IN 1991

The thirty-year history of Promet Company is bright victories, hard work, overcoming crises and difficulties that have only made us stronger.

We have achieved a lot – this is not only the company's knowledge of the market, but also the success of our partners. Now Promet is an extensive dealer network, the best professionals, modern equipment and well-established processes.

A new time has come and this is the time of maturity, high professionalism and moving forward.



37 Subsidiaries
in Russia



4 Factories



Export in **76**
countries



9 Foreign
subsidiaries



2000 More than
articles



2800 Job
places

PROMET PROFI

PROFESSIONAL CHOICE

Profi W



WORKBENCHES Profi W

Designed for convenient workplace organization at schools, workshops and garages. Workbenches can be purchased as a set, or assembled from optional components.



● **Colour:**  RAL 7038  RAL 5002

- 5 tabletop BASE Models - MDF 24 mm + galvanized steel sheet 1,2 mm
- 3 pedestal types WD-1 (1 door), WD-2 (1 door and 1 drawer), WD-5 (5 drawers), max load per drawer and shelf – 30 kg
- Ball-bearing slides for drawers
- Pedestals has the possibility of door opening side change
- Key lock (2000 combinations) 2 keys included
- Delivered disassembled on major parts

! What is needed to set the workbench



Perforated panel WS



Dimensions (HxW), mm
500x1000/1200/1400/1600/1800
Steel 1,2 mm
Square perforation: 10x10mm,
step 38 mm



Set of triangles

for perforated panels
W mounting



Dimensions (HxWxD),
mm: 505x210x45



Tabletop WT



Dimensions (DxW), mm:
700x1000/1200/1400/1600/1800
Galvanized steel cover 1,2 mm,
MDF 24 mm

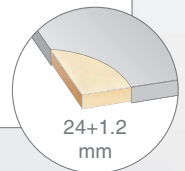

**Pedestal
WD**



**Leg
WF-1**

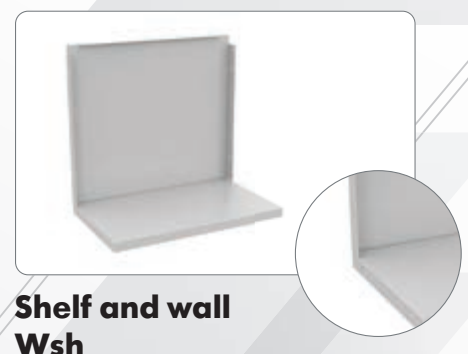

**Shelf and wall
Wsh**

Ready sets of workbenches Profi W

Workbenches 1000 mm



WT 100.F1/F1.000



WT 100.WD1/F1.000*



WT 100.WD2/F1*



WT 100.WD5/F1.000*



WT 100.WD5/WD1.000

Workbenches 1200 mm



WT 120.F1/F1.000



WT 120.WD1/F1.000



WT 120.WD2/F1.000



WT 120.WD5/F1.000



WT 120.WD5/WD1.000*

Workbenches 1400 mm



WT 140.WD1/F1.000



WT 140.WD2/F1.000



WT 140.WD5/F1.000



WT 140.WD5/WD1.000*



WT 140.WD2/WD1.000*

Workbenches 1600 mm



WT 160.WD1/F1.000



WT 160.WD2/F1.000



WT 160.WD5/F1.000



WT 160.WD1/WD2.000



WT 160.WD5/WD5.000

Workbenches 1800 mm



WT 180.WD1/WD1.000



WT 180.WD1/WD2.000



WT 180.WD2/WD5.000



WT 180.WD1/WD5.000



WT 180.WD5/WD5.000

* Shelf and wall is not applicable

Type of tabletop WT

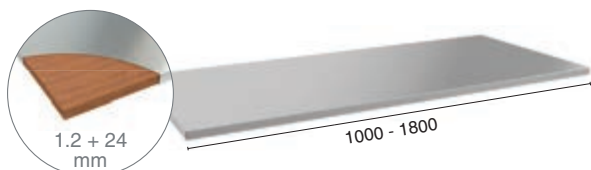

Dimensions (DxW), mm
700x1000/1200/1400/1600/1800
Galvanized steel cover 1,2 mm + MDF 24 mm

Possible to install the Expert tabletops

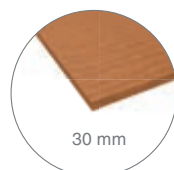

W

Plywood 30 mm



WTS

Plywood 30 mm + galvanized steel cover 1,5 mm



WTH

Plywood 30 mm + painted steel sheet (RAL 7038) 3 mm



Cover W 200

RAL 7038, steel 5 mm

Sets of perforated panels for workbenches **Profi W**

■ Perforated panel 1000 mm



- Perforated panel WS 100
- Set of triangles

WS 100.1.0



- Perforated panel WS 100
- Set of triangles
- Light set

WS 100.1.1



- Perforated panel WS 100 2 pcs.
- Set of triangles
- 2 panel fix brackets

WS 100.2.0



- Perforated panel WS 100 2 pcs.
- Set of triangles
- Light set

WS 100.2.1



■ Perforated panel 1200 mm



- Perforated panel WS 120
- Set of triangles

WS 120.1.0



- Perforated panel WS 120
- Set of triangles
- Light set

WS 120.1.1

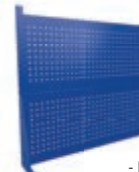

- Perforated panel WS 120 2 pcs.
- Set of triangles
- 2 panel fix brackets

WS 120.2.0

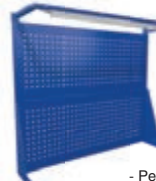

- Perforated panel WS 120 2 pcs.
- Set of triangles
- Light set

WS 120.2.1



■ Perforated panel 1400 mm



- Perforated panel WS 140
- Set of triangles

WS 140.1.0



- Perforated panel WS 140
- Set of triangles
- Light set

WS 140.1.1

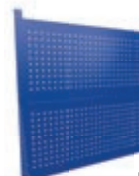

- Perforated panel WS 140 2 pcs.
- Set of triangles
- 2 panel fix brackets

WS 140.2.0



- Perforated panel WS 140 2 pcs.
- Set of triangles
- Light set

WS 140.2.1



■ Perforated panel 1600 mm



- Perforated panel WS 160
- Set of triangles

WS 160.1.0



- Perforated panel WS 160
- Set of triangles
- Light set

WS 160.1.1



- Perforated panel WS 160 2 pcs.
- Set of triangles
- 2 panel fix brackets

WS 160.2.0

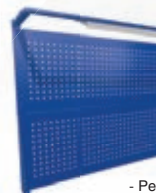

- Perforated panel WS 160 2 pcs.
- Set of triangles
- Light set

WS 160.2.1



■ Perforated panel 1800 mm



- Perforated panel WS 180
- Set of triangles

WS 180.1.0



- Perforated panel WS 180
- Set of triangles
- Light set

WS 180.1.1

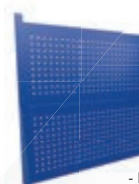

- Perforated panel WS 180 2 pcs.
- Set of triangles
- 2 panel fix brackets

WS 180.2.0

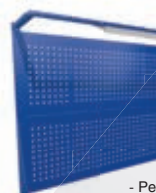

- Perforated panel WS 180 2 pcs.
- Set of triangles
- Light set

WS 180.2.1



* Max load per perforated panel - 50 kg / 2x50 kg

+ OPTIONS

Light set W

Led light:
Voltage 220 V;
Power 11Wt;
Light output 880 Lm;
Light temperature 4000K;
Length 835 mm.

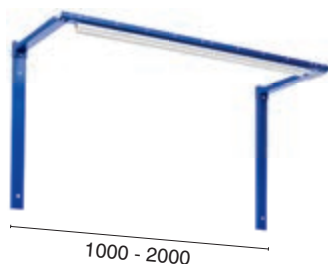

Set of triangles

for perforated panels WS installing
Steel 1,2 mm

Dimensions
HxWxD, mm: 505x210x45



Brackets

for 2 perforated panels mounting



Options for workbenches **Profi W**

Pedestal WD-1

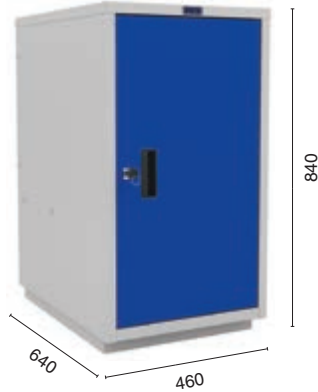

Max load per shelf



Door, 2 detachable, high adjustable shelves
Door opening side can be changed

Pedestal WD-2



Max load per shelf



Max load per drawer



Ball bearing slides

Int. dimensions HxWxD, mm:
Small drawer: 100x380x600

Pedestal WD-5

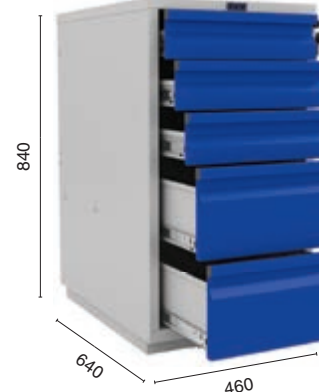

Max load per drawer

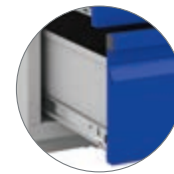

Ball bearing slides



Central Key Lock

Int. dimensions HxWxD, mm:
Small drawer: 100x380x600
Large drawer: 190x380x600

Drawer set WD-0

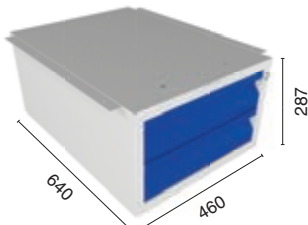

Max load per drawer

Installed under the tabletop of workbenches Profi, Expert

2 detachable, high adjustable shelf. Door opening side can be changed. Small drawer is equipped with ball-bearing slides, key lock.

Small drawer - 3 pcs.,
Large drawer - 2 pcs.,
Ball-bearing slides and central key lock.

Tabletop WT 100/120/140/160/180

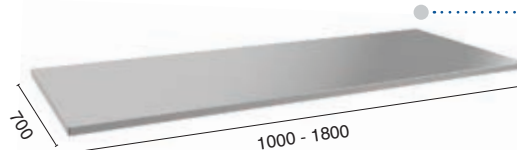

1.2 + 24 mm

Galvanized steel cover 1,2 mm + MDF 24 mm

Hanging cabinet Profi WD

Can be mounted on the wall or workbench perforated panel

Key lock (2 keys included). Plastic handle. Detachable shelf. Door opening side change.



Max load per cabinet

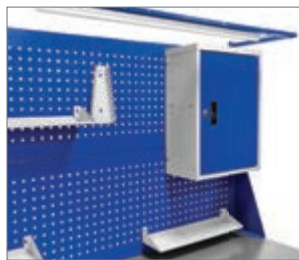
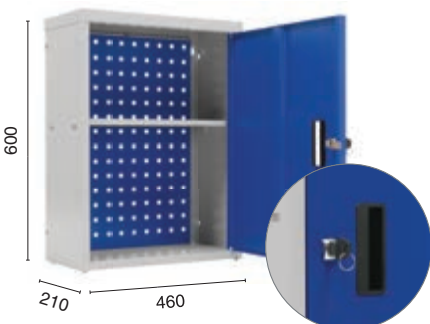

Options of installing

Perforated panel WS 60

Can be fixed in different ways:

- To the wall (4 pcs fasteners included)
- Between 2 hanging cabinets Profi WD by hooks
- Possibility to join several panels using hooks

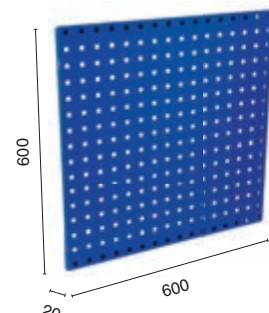

Options for workbenches **Profi W**

Shelf and wall Wsh

Manual for installation of shelf and wall Wsh



Workbench Tabletop	Tabletop WT-100	Tabletop WT-120	Tabletop WT-140	Tabletop WT-160	Tabletop WT-180
Leg-Leg No pedestal	WSh-160/2 	WSh-120/0* 	—	—	—
Pedestal-Leg Workbench with 1 pedestal and leg	—	WSh-120/1 	WSh-140/1* 	WSh-160/1* 	—
Pedestal-Pedestal Workbench with 2 pedestals	—	—	—	WSh-160/2 	WSh-180/2*, **

* If only wall used, the tool trolley WDS-4 can be hidden under the tabletop

** If using Expert tabletop W-200 with Profi pedestals please use shelf and wall WSh-180/2

Leg WF-1

Steel 1,2 mm

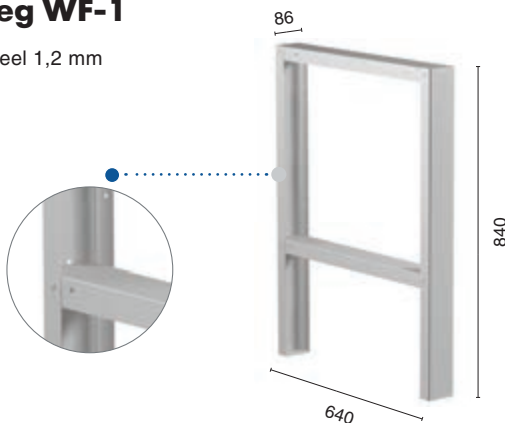

Perforated panel WS 100/120/140/160/180

Steel 1,2 mm

For tabletop WT-100/120/140/160/180

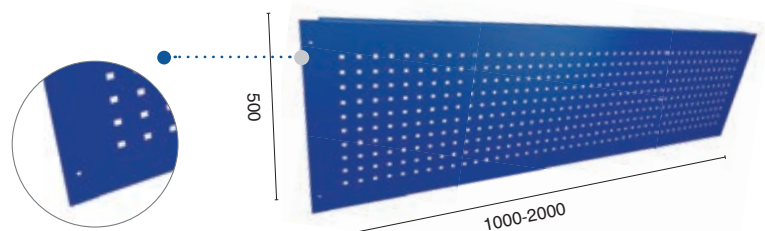
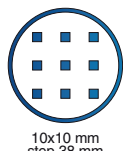

Accessories please see on page 24

+ OPTION

Set of triangles for perforated panel WS

Steel 1,2 mm

Dimensions HxWxD, mm:
505x210x45

+ OPTION



Light set W

Led light:
Voltage 220 V;
Power 11 Wt;
Light output 880 Lm;
Light temperature 4000 K;
Length 835 mm.

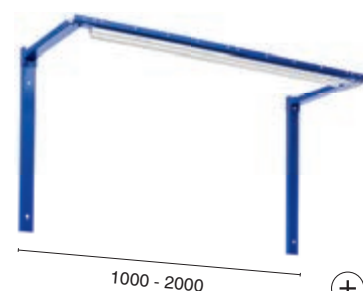

+ OPTION

Workbench Expert T

Steel locksmith and carpentry workbenches of the Expert T series are a new series of workbenches with increased loads. Modular construction. Designed for convenient workplace organization at industrial enterprises in car service stations and workshops.



- **Colour:** RAL 7035 RAL 7016
- The possibility of creating a workplace tailored to individual requirements.
- Manufactured in 4 sizes in width of 1200, 1500, 1600, 2000 mm, in depth of 750 mm. Tabletops made of 30 mm plywood and 1,5 mm galvanized steel or painted 3 mm steel cover. Max load is up to 3000 kg.
- Two types of pedestals: Expert T-1 (1 door) with load per shelf up to 240 kg, and Expert T-6 (6 drawers), max load per drawer up to 120 kg. Each drawer is equipped with a tag holder. Anti-tilt mechanism included.

! What is included in workbench kit



Perforated panel Profi M



1,2 mm steel
Dimensions: HxW, mm:
500x1200/1500/1600/2000
Square perforation 10x10 mm,
step 38 mm

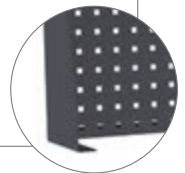

Set of triangles

For installing on perforated panels



2 mm steel



Two types of pedestal T-1 T-6



Tabletops

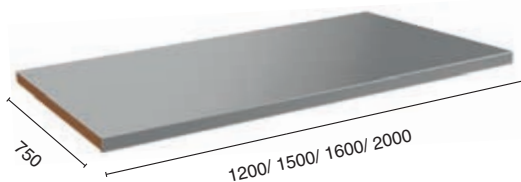

W
30 mm
plywood

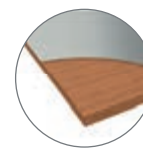

WTH
30 mm
+ 3 mm painted
steel cover

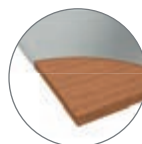

WTS
30 mm plywood
+ 1,5 mm
galvanized steel
cover

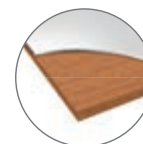

Cover W 200
5 mm steel, RAL 7038

Components for workbenches Expert T

Pedestal T-1

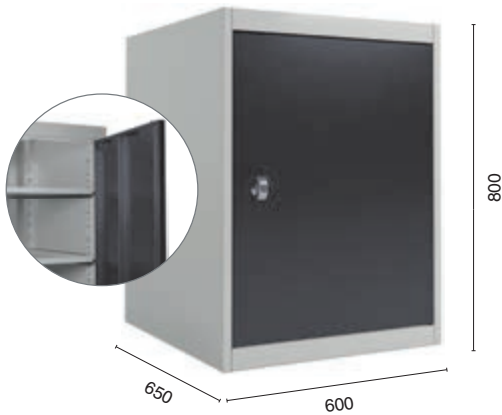

With door, two adjustable shelves

Pedestal T-6



Dimensions H x W x D,mm: 75x500 x 500/175x500x500
6 drawers, equipped with anti-slippery mats. Ball bearing slides.
Central key lock.

Tabletops

Dimensions:
Width – 1200/1500/1600/2000 mm
Depth – 750 mm



W W-120/150/160/200
30 mm plywood



WTS WTS-120/150/160/200
30 mm plywood + 1,5 mm galvanized steel cover



WTH WTH-120/150/160/200.
1,2 inch plywood + 11 gauge painted steel cover

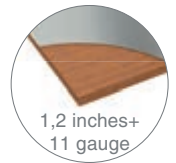

RAL 7038

Cover for W 200

5 mm painted steel cover
RAL 7038



Light set Profi M

⊕ OPTION

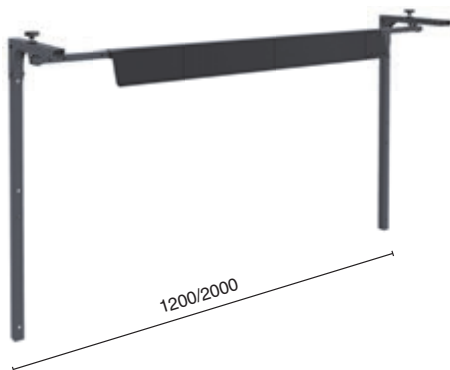

Led light set:
Luminous flux 5460 Lm;
Power 24 Wt;
Colour temperature – white 2500k.

Set of triangles

For installing on perforated panels

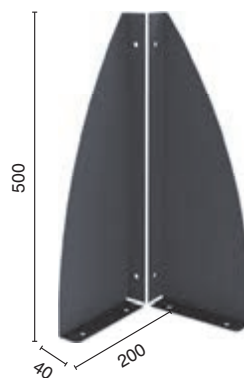

1,2 mm steel

⊕ OPTION

Double perforated panel mounting bracket



1,5 mm steel

⊕ OPTION

Reinforced workbenches **Profi M**

Steel locksmith workbenches series – Profi M is a new series of workbenches with increased loading and rigidity. Modular structure (pedestals and supports are welded). They are designed for convenient organization of the workplace at industrial enterprises, in autoservice stations and workshops.



- **Colour:** RAL 7038 RAL 7024
- Manufactured in two standard sizes. With the tabletop width 1600 and 2000 mm, with a depth of 704 mm. Table tops made of plywood 24mm with cover made of painted steel 3 mm or galvanized steel 1.5 mm. The permissible distributed load is up to 1.5 t.
- Three types of pedestals: Profi M-1 (1 door), Profi M-4 (4 drawers), Profi M-5 (5 drawers), Max drawer load is 90 kg. Each drawer is equipped with a tag holder, complete with a set of pictograms to indicate the stored tool. Anti-tilt mechanism.
- Rubberized side bumpers on the pedestals and legs protect the ends of the workbench from unintentional damage.
- The side perforated walls of the pedestal allow you to place various attachments on them (tool holders, screwdrivers, keys, cans, etc.).

! What is needed to set the workbench



Perforated panel Profi M



Steel 1,2 mm

Dimensions HxW, mm:
500x1600/2000
Square perforation:
10x10 mm, step 38 mm

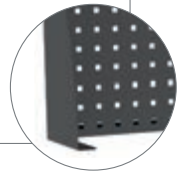

Set of triangles

For perforated panels Profi M

Steel 1,2 mm



Tabletop Profi M

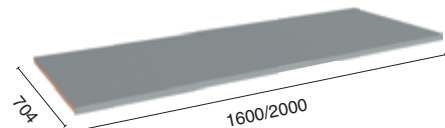

MTS



MTH

Plywood 24 mm + galvanized steel cover 1,5 mm or painted steel cover 3 mm, RAL 7038

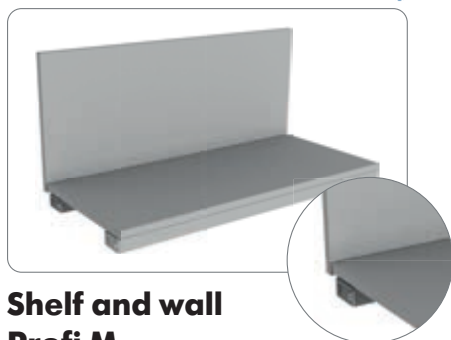

Shelf and wall Profi M

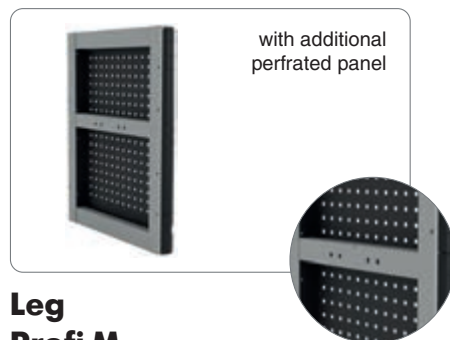

Leg Profi M

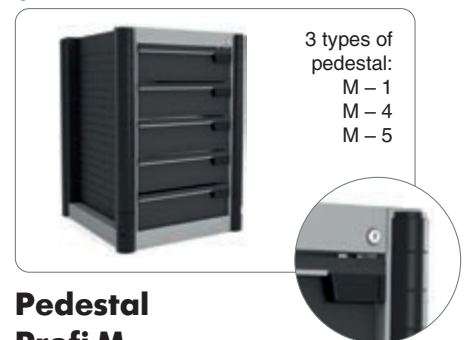

Pedestal Profi M

3 types of pedestal:
M – 1
M – 4
M – 5

Options for workbenches Profi M

Pedestal Profi M1

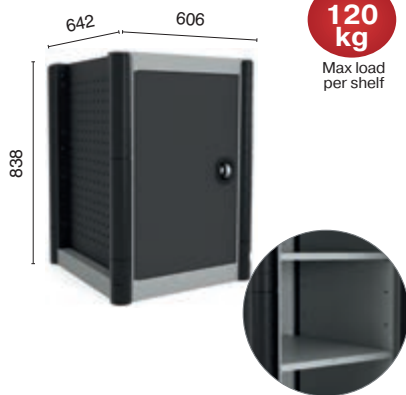

120 kg
Max load per shelf

With a door, 2 removable adjustable shelves, 80 mm pitch. The possibility of changing the side of the door opening. Key lock.

Pedestal Profi M4

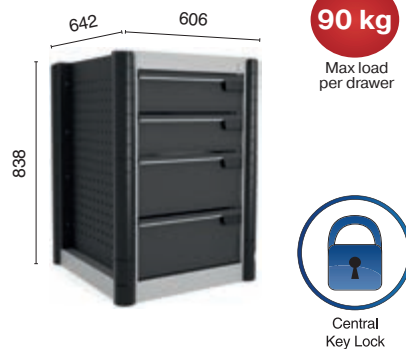

90 kg
Max load per drawer

Central Key Lock

Drawers internal dimensions, HxWxD, mm: 122x410x565 / 190x410x565

4 drawers. Ball-bearing slides. Central key lock (2000 combinations), 2 keys included.

Pedestal Profi M5

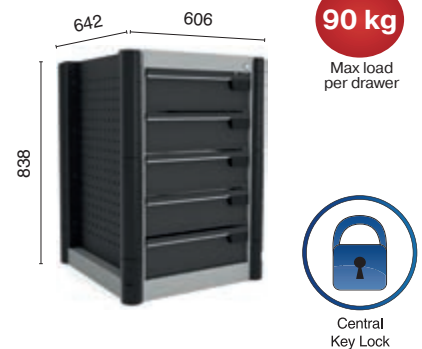

90 kg
Max load per drawer

Central Key Lock

Drawers internal dimensions, HxWxD, mm: 122x410x565

5 drawers. Ball-bearing slides. Central key lock (2000 combinations), 2 keys included.



Each drawer is equipped with a tag holder, complete with a set of pictograms to indicate the stored tool.

Tabletop MTS

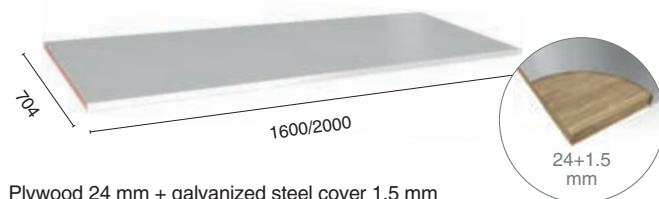

Plywood 24 mm + galvanized steel cover 1,5 mm

Tabletop MTH

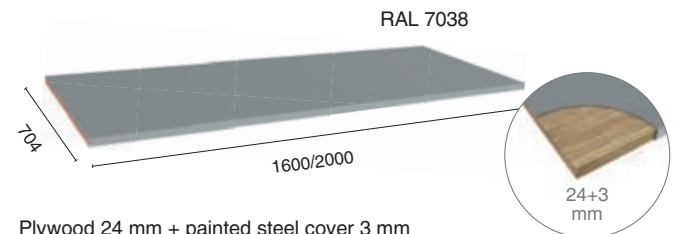

Plywood 24 mm + painted steel cover 3 mm

Perforated panel Profi M-160/M-200

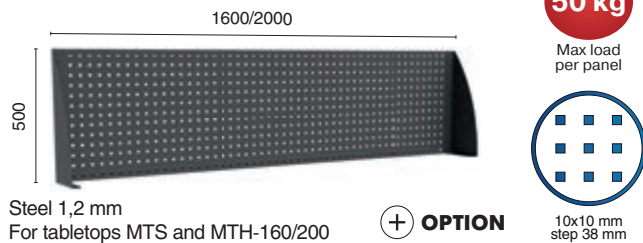

50 kg
Max load per panel

10x10 mm step 38 mm

Steel 1,2 mm
For tabletops MTS and MTH-160/200

+ OPTION

Shelf and wall Profi M

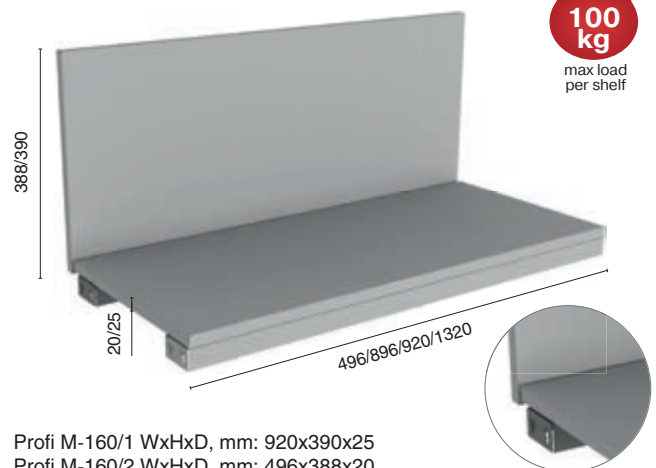

100 kg
max load per shelf

Profi M-160/1 WxHxD, mm: 920x390x25
Profi M-160/2 WxHxD, mm: 496x388x20
Profi M-200/1 WxHxD, mm: 1320x390x25
Profi M-200/2 WxHxD, mm: 896x388x20

The shelf and wall can be installed as a back wall in two levels, or as a shelf and a wall in a standard version.

Leg Profi M

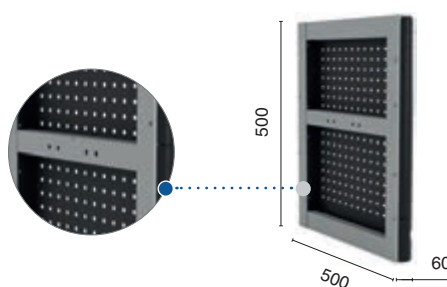

With additional perforated panel

Ready sets of workbenches **Profi M**

■ Workbenches 1600 mm



MTS 160.PM1.M.000



MTS 160.PM5.M.000



MTH 160.PM4.M.000



MTS 160.PM1/PM1.000



MTH 160.PM4/PM5.000



MTS 160.PM1/PM5.000

■ Workbenches 2000 mm



MTS 200.PM1.M.000



MTS 200.PM4.M.000



MTH 200.PM5.M.000



MTS 200.PM5/PM1.000



MTH 200.PM1/PM4.000



MTS 200.PM5/PM5.000

Set of perforated panels for workbenches **Profi M**

■ Perforated panel 1600 mm



MS 160.1.0

- Perforated panel Profi M-160
- Set of triangles



MS 160.1.1



- Perforated panel Profi M-160
- Set of triangles
- Light set Profi M

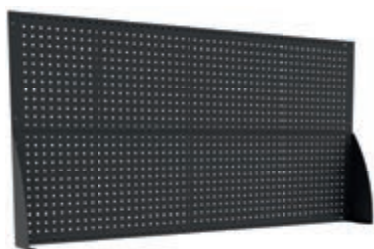

MS 160.2.0

- Perforated panel Profi M-160 - 2 pcs.
- Set of triangles
- Brackets to fix 2 perforated panels

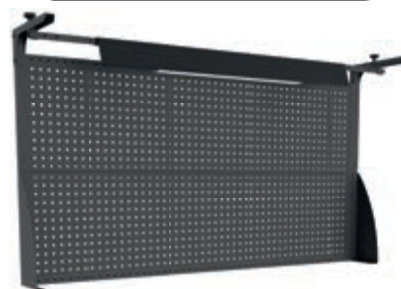

MS 160.2.1



- Perforated panel Profi M-160 - 2 pcs.
- Set of triangles
- Light set Profi M

■ Perforated panel 2000 mm



MS 200.1.0

- Perforated panel Profi M-200
- Set of triangles



MS 200.1.1



- Perforated panel Profi M-200
- Set of triangles
- Light set Profi M

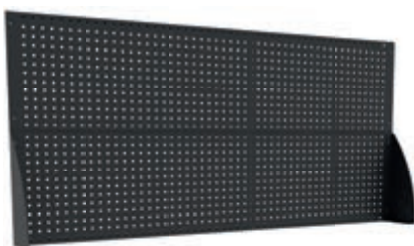

MS 200.2.0

- Perforated panel Profi M-200 - 2 pcs.
- Set of triangles
- Brackets to fix 2 perforated panels

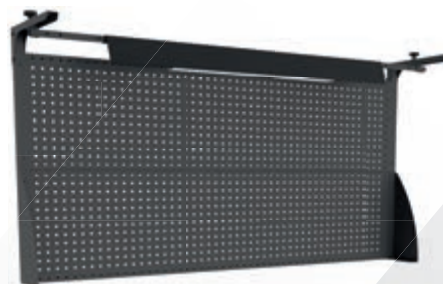

MS 200.2.1



- Perforated panel Profi M-200 - 2 pcs.
- Set of triangles
- Light set Profi M

Light set Profi M

Led light:
Luminous flux 5460 Lm;
Voltage 220 V;
Power 24 Wt;
Colour temperature – white 2500 K;
Length 1150 mm.

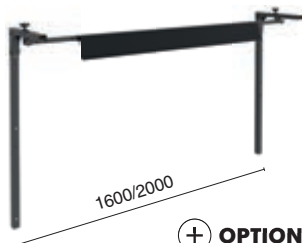

⊕ OPTION

Set of triangles

For perforated panels Profi M mounting

Steel 1,2 mm

⊕ OPTION

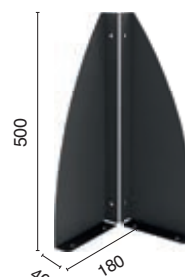

Brackets

For 2 perforated panels Profi M mounting

Steel 1,2 mm

⊕ OPTION







Workbench Master



Metal workbenches Master series are designed for convenient organization of the workplace in garages, workshops, schools and even on the balconies, due to the compact size.

- **Colour:**  Galvanized  RAL 5002
- **Resistant to high humidity.** Main elements are manufactured from galvanized steel.
- **Compact sizes 1000x500 mm.** Can be installed at the places with limited area.
- **Convenient storage.** Possibility to store 4 tyres R15 195/65, R16 205/55.
- **Module structure.** Can be installed in one line with common support in the middle.
- Delivered disassembled.
- One box flat packed.

! What is needed to set the workbench



Tabletop M-100



Plywood 24 mm, treated with a colourless varnish



Tabletop MT-100



Plywood 24 mm + galvanized steel cover 1,2 mm



Shelf M -100

Galvanised steel

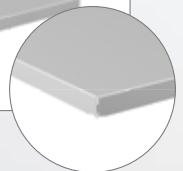
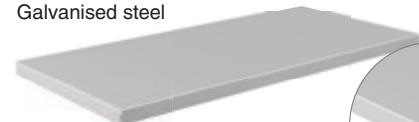

Leg MF-1



Plastic plug for legs

(included)



Saddle MS Pro



Saddle with a hole for the anchor. It is attached to the leg with two M8 bolts.



Drawer M -140

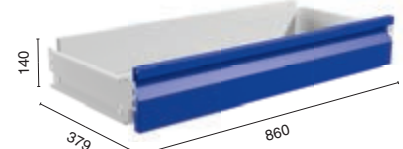

Beam M 90

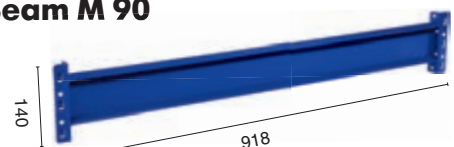

Ready sets of workbenches Master



Master 101



Master 102



Master 103
(Drawer included)



Master 104
(drawer and shelf included)



Master 105
(two drawers and shelf included)



Master 106
(two shelves included)



Master 109
(two shelves and 1 drawer included)



Master 110
(3 drawers included)



Master 111
(2 drawers included)



Master 107
(Two workbenches at common leg)

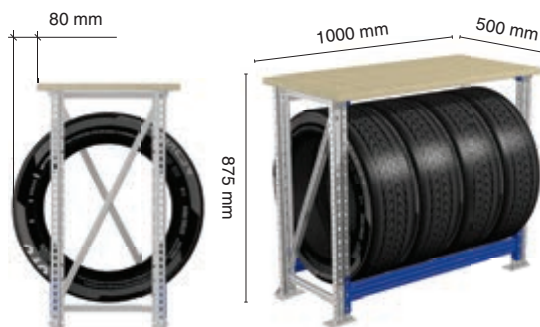

Workbench for tire storage
R15 195/65, R16 205/55



Compact size package

Options for workbenches **Master**

Perforated panel WS

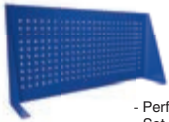

- Perforated panel WS 100
- Set of triangles

WS 100.1.0



- Perforated panel WS 100
- Set of triangles
- Light set

WS 100.1.1



- Perforated panel WS 100, 2 pcs.
- Set of triangles
- Brackets for fixing 2 perforated panels

WS 100.2.0



- Perforated panel WS 100, 2 pcs.
- Set of triangles
- Light set

WS 100.2.1

Tabletop

M - 100

Plywood 24 mm, treated with a colourless varnish



Max load



Plywood 24 mm

MT - 100

Plywood - 24 mm + galvanized steel cover 1,2 mm

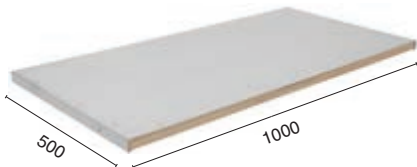

24+1.2 mm

Plywood 24 mm + galvanized steel 1,2 mm

Leg MF - 1

The design of the support leg is dismantlable. It consists of two vertical racks connected to each other by a horizontal and diagonal connection.

The stand is manufactured from galvanized steel profile 56x47 mm

Perforation step 50 mm

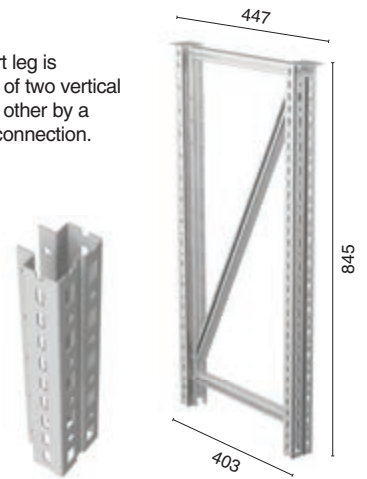

Plastic plugs for legs



Saddle MS Pro



Saddle with a hole for the anchor. It is attached to the leg with two M8 bolts.

+ **OPTION**

Shelf M - 100

Galvanized steel, 1 mm

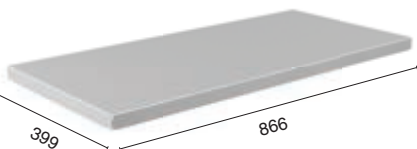

Max load per shelf

Beam M 90

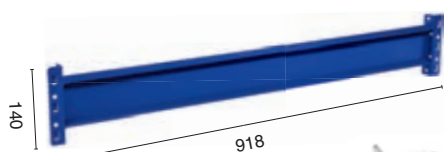

Fastening of the beam to the racks is boltless. The beam is attached to the rack on hooks.



Beam profile

Hooks

Drawer M - 140

(Max capacity for workbench - 4 pcs.)



Max load per drawer



Ball bearing slides

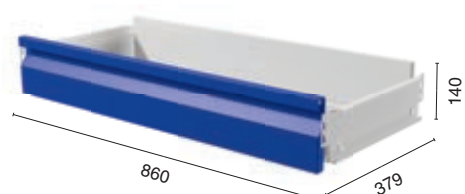

Workbenches **Garage**

Designed for convenient workplace organization in garages, private workshops, small enterprises and even balconies.

● **Colour:**  RAL 7038  RAL 5002

- **Fast and easy assembly**
- **Compact sizes 1000x500 mm**
- Two types of tabletop. MDF 16 mm + galvanized steel cover 1,2 mm or 20 mm plywood covered with transparent varnish
- Max permitted load – 300 kg
- Compact package. One box flat packed
- Delivered disassembled



Sets of workbenches **Garage**



Garage XS

21 mm plywood tabletop. 1 shelf; 4 legs with caps, perforated panel 100x500 mm, 3 accessories (tool holder, wrench holder, small shelf)

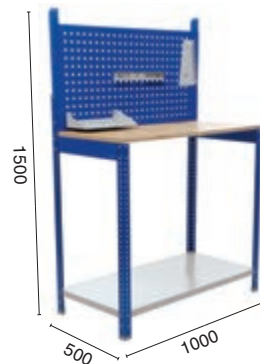

Garage S

21 mm plywood tabletop. 1 shelf; 4 legs with caps, 2 drawers garage, perforated panel 100x500 mm, 3 accessories (tool holder, wrench holder, small shelf)

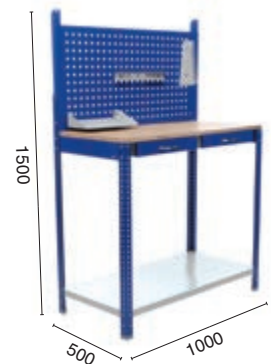

Garage L (Set 1)

21 mm plywood table top. 1 shelf; 4 legs with caps, perforated panel 100x500 mm, 3 accessories (tool holder, wrench holder, small shelf), led light set and 2 drawers included

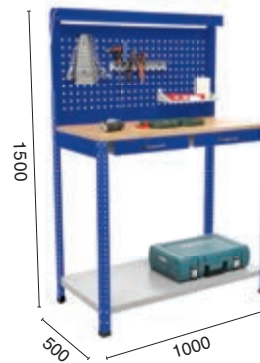

Garage L (Set 2)

MDF 16 mm + galvanized steel cover 1,2 mm shelf; 4 legs with caps, perforated panel 100x500 mm, 3 accessories (tool holder, wrench holder, small shelf), led light set and 2 drawers included



Special **Garage set**

Garage set XL

MDF 16 mm + galvanized steel cover 1,2 mm shelf; 4 legs with caps, perforated panel 100x500 mm, 2 drawers, light set 2 shelves, 7 accessories (tool holder, wrench holder, small shelf, towel holder, spray can holder, 5 hooks and 2 spring hooks)

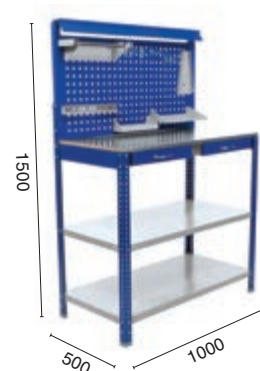

Garage set XXL

MDF 16 mm + galvanized steel cover 1,2 mm shelf; 4 legs with caps, 2 perforated panels 120x500 mm, 2 heavy duty drawers, light set 2 shelves, Profi Wd cabinet, 10 accessories (tool holder, wrench holder, small shelf, towel holder, spray can holder, drill bit holder, hex key holder, 5 hooks and 2 spring hooks) electric supply set.



Options for workbenches **Garage**

In addition it is possible to add more shelves, led light set, drawers (only for XS) and different accessories for perforated panel (see page 32)

Light set W



Led light:
Voltage 220 V;
Power 11 Wt;
Light output-880 Lm;
Light temperature-4000 K;
Length-835 mm.

Shelf MS Standart 100(120) x 50

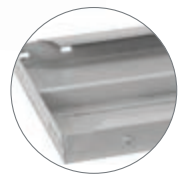
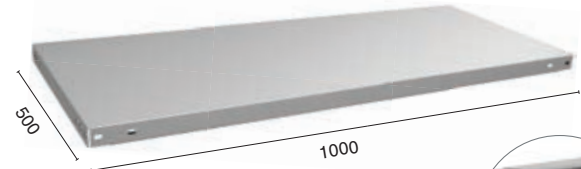

Central stiffener

Flat packed



Drawer Garage



Set of side perforated panels Garage MS

Steel 0,8 mm
HxWxD, mm: 20x398x500

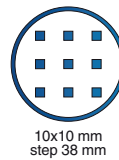
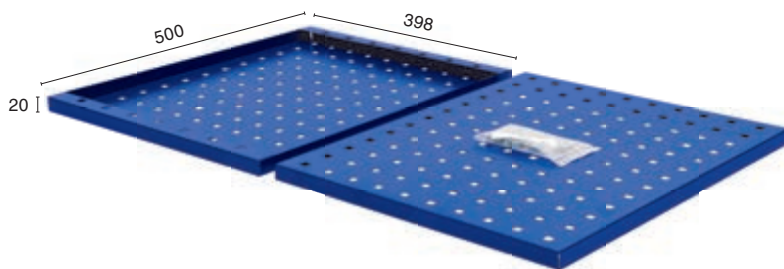

Can be mounted on workbench and tool trolley Garage (as from one side, so to the both sides) fixtures are included.



PROMET **PROFI**

PROFESSIONAL CHOICE

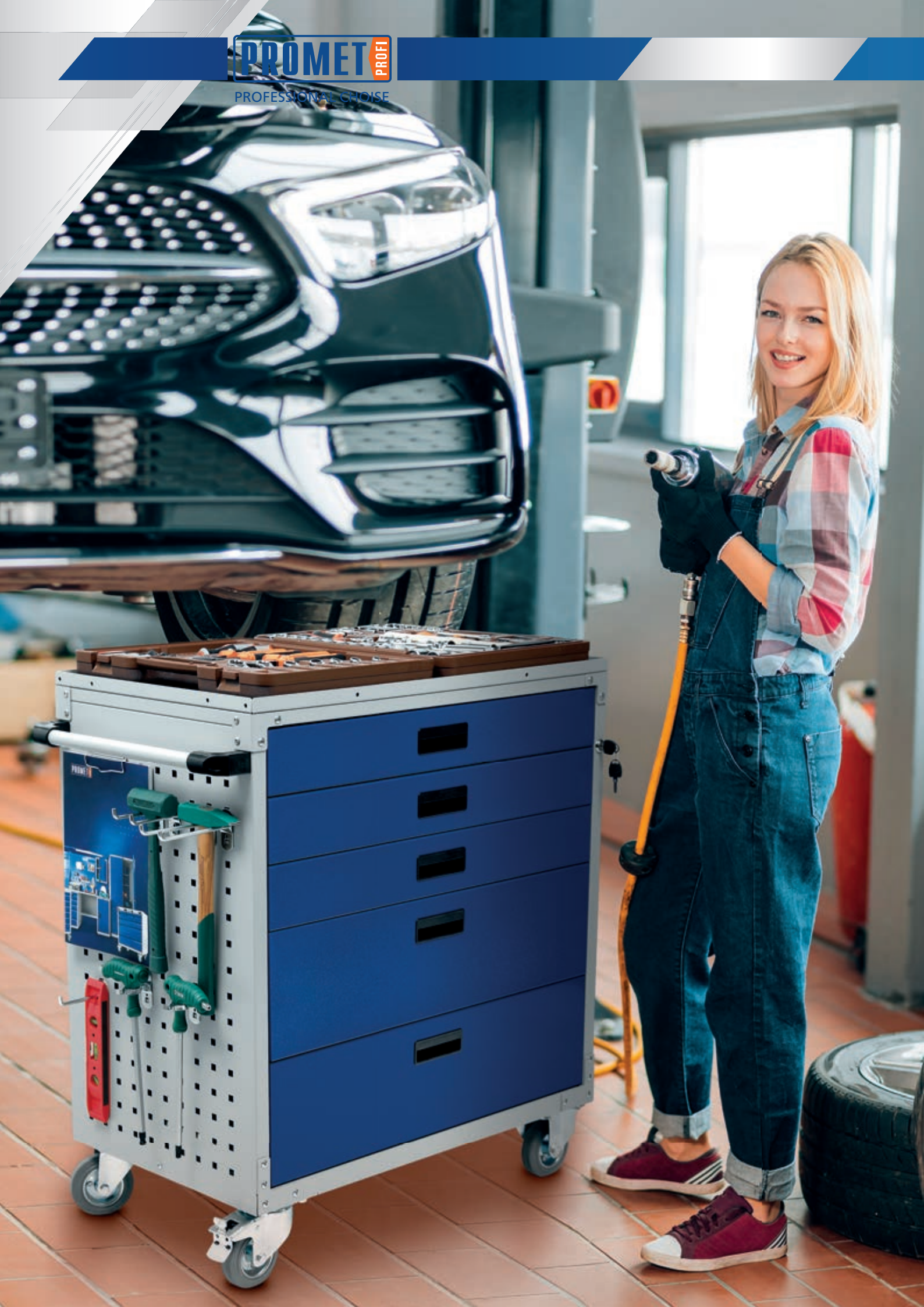

Tool trolley Garage

Tool trolleys are designed for storage and rapid movement of tools and equipment at home, private workshops, in auto service stations and repair shops.

● **Colour:**  RAL 7038  RAL 5002

- Manufacture from high-strength steel
- Drawers included (some sets)
- Light weight
- Four wheels included

33 kg
Max load per shelf



Tool trolley Garage Big



150 kg
Max load per trolley

Five adjustable shelves. Possibility to install up to 7 drawers Garage. Two convenient handles. Can be used for outdoor trading and garden storage.



* Height without wheels

Tool trolley Garage



100 kg
Max load per trolley

The top shelf is equipped with MDF board and oil resistant rubber mat.



Tool trolley Garage D



100 kg
Max load per trolley

The top shelf is equipped with MDF board and oil resistant rubber mat.



Side perforated panels Garage MS

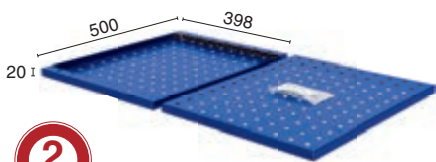

20 kg
Max load on one screen

2
Pcs INCLUDED

+ OPTION

Tool trolley Garage XL



100 kg
Max load per trolley

The top shelf is equipped with MDF board and oil resistant rubber mat. Other shelves equipped with rubber mat. 3 side perforated panels, 3 drawers, set of accessories.



Drawer for tool trolley Garage

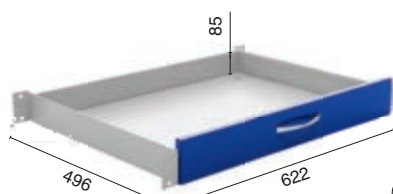

5 kg
Max load per drawer

+ OPTION

Tool trolleys **WDS**

Tool trolleys are designed for convenient storage and transportation of tools and spare parts at manufacturing enterprises, car service stations and different workshops.

● **Colour:**  RAL 7038  RAL 5002

- Manufactured from high-strength steel
- Ball bearing slides for drawers
- Full drawer extension system
- Equipped with comfortable handles and rubber covered wheels
- The top is equipped with oil resistant rubber mat
- Delivered assembled (except WDS-0)



Max load per small drawer



Max load per large drawer



Full drawer extension



Wheels included



100 mm
Wheels diameter



Ball bearing slides

Tool trolley WDS 0



Max load per trolley



Max load per 2 top shelves



Max load per bottom shelf



Open type trolley. 3 adjustable shelves (step 50 mm), Rubber mat for the top shelf. 4 wheels 100mm. One with brake.

Tool trolley WDS 9



Max load per trolley



Max load per top



Central Key Lock



Small drawer – 6 pcs.
Large drawer – 3 pcs.

Dimensions HxWxD, mm:
Small drawer: 56x447x549
Large drawer: 129x447x549

Tool trolley with installed wheels

+ OPTION

Perforated panel WDS

Steel 0,8 mm
Can be mounted on tool trolleys WDS 0/4/5/6

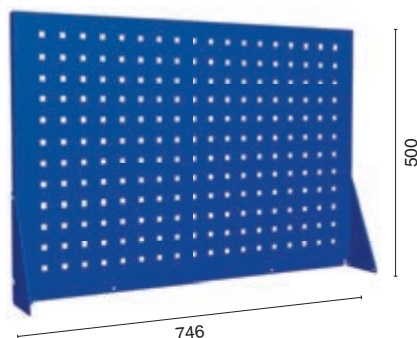

Wheels set, 4 pcs.



for Tool trolley WDS 9



per wheel

Ø100 mm

+ OPTION

Handle WS



+ OPTION

Tool trolleys WDS

Tool trolley WDS 4



Small drawer – 2 pcs. Large drawer – 2 pcs.
 Dimensions HxWxD, mm:
 Small drawer: 75x655x400
 Large drawer: 170x655x400
 All wheels are rotatable

*Height without wheels



180 kg

Max load per trolley



40 kg

Max load per top



25 kg

Max load per small drawer



30 kg

Max load per large drawer



Central Key Lock

Tool trolley WDS 5.0

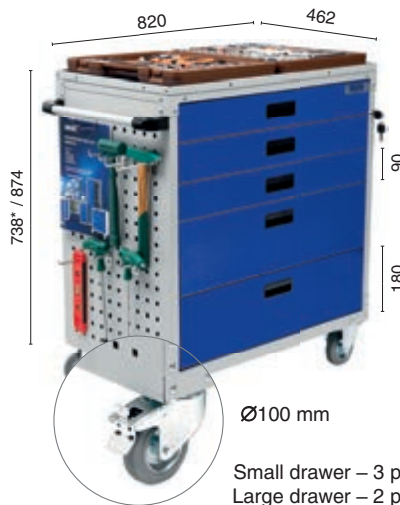

Small drawer – 3 pcs.
 Large drawer – 2 pcs.
 Dimensions HxWxD, mm:
 Small drawer: 75x655x400
 Large drawer: 175x655x400

Tool trolley WDS D-6.1

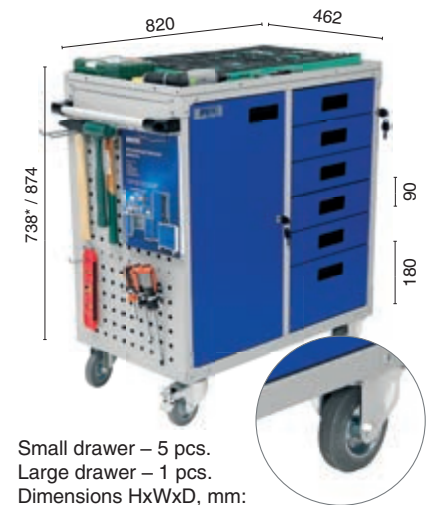

Small drawer – 5 pcs.
 Large drawer – 1 pcs.
 Dimensions HxWxD, mm:
 Small drawer: 75x300x400
 Large drawer: 175x300x400
 Niche: 690x359x400

Set of partitions WDS

+ OPTION



Tool trolley WDS HARD

4 heavy-duty wheels (two with brake)
 diameter - 100 mm



400 kg

Max load per trolley

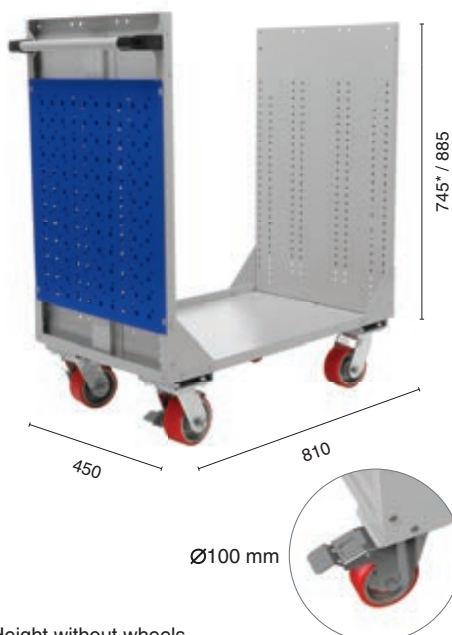

* Height without wheels

CNC storage shelf + OPTIONS

SK 40*
 (14 pcs.)



SK 50*
 (6 pcs.)



HSK 63*
 (14 pcs.)



* see. p. 80



50 kg

Max load per shelf



Shelves can be installed horizontally or by 20 degree angle



Shelf HARD + OPTION



100 kg

Max load per shelf

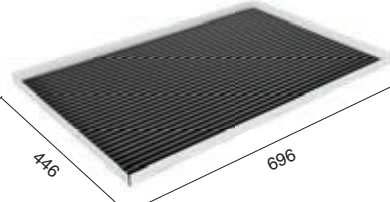



* Shelves have to be purchased separately (the rubber mat is included)



TOOL TROLLEYS **WDS-x.0 NEW**



Designed for secure storage and transportation of tools and spare parts at manufacturing enterprises, car service stations and different workshops and factories. Can be used in Lean manufacturing system of enterprises and mobile workplaces.

● **Colour:**  RAL 7038  RAL 7024

- Welded structure, steel - 0,8 mm
- 3 types of drawers, steel thickness 1 mm
- Ball bearing slides with spring locks (button on the handle), anti-tilt mechanism
- Side rubber-plastic buffers
- Perforated side walls for installing accessories (same as for workbench perforated panels)
- Ergonomic handle
- Delivery semi-asssembled (2 boxes)



Tool trolley WDS-3.0

Central Key Lock

Dimensions HxWxD, mm
Large drawer – 3 pcs.:
198x554x469

Tool trolley WDS-5.0

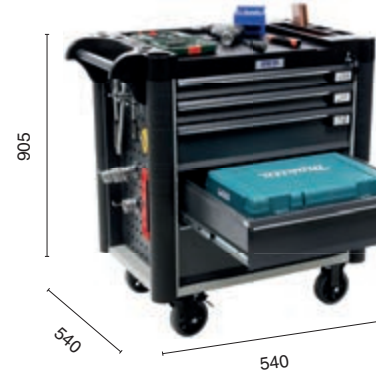

Central Key Lock

Dimensions HxWxD, mm:
Small drawer – 3 pcs.:
58x554x469
Medium drawer – 2 pcs.:
128x554x469
Large drawer – 3 pcs.:
198x554x469



Tool trolley WDS-6.0



Central Key Lock

Dimensions HxWxD, mm:
Small drawer – 3 pcs.:
58x554x469
Medium drawer – 2 pcs.:
128x554x469

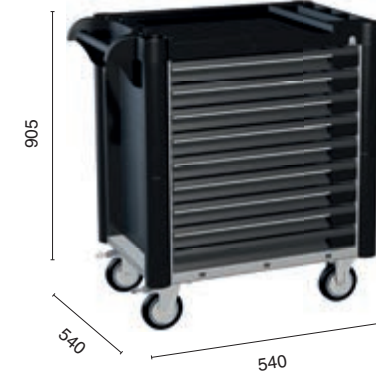
Tool trolley WDS-9.0

Central Key Lock

Dimensions HxWxD, mm:
Small drawer – 9 pcs.:
58x554x469

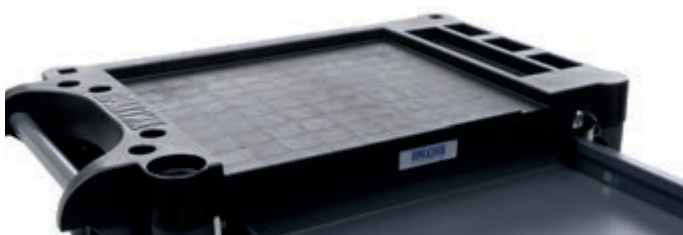

The top (black plastic) is equipped with lodgements for tools. Ball bearing slides for drawers.



Wheels with unmarked rubber with a diameter of 125 mm (two rotary with a brake, two non-rotating without a brake).

TOOL TROLLEYS WDS-x.1 NEW

Designed for secure storage and transportation of tools and spare parts at manufacturing enterprises, car service stations and different workshops and factories. Can be used in Lean manufacturing system of enterprises and mobile workplaces.

● **Colour:**  RAL 7038  RAL 7024

- Welded structure, steel - 0,8 mm
- 3 types of drawers, steel thickness 1 mm
- Lockable compartment with removable height-adjustable shelf
- Ball bearing slides with spring locks (button on the handle), anti-tilt mechanism
- Side rubber-plastic buffers
- Perforated side walls for installing accessories (same as for workbench perforated panels)
- Ergonomic handle
- Delivery semi-assembled (2 boxes)



Tool trolley WDS-3.1

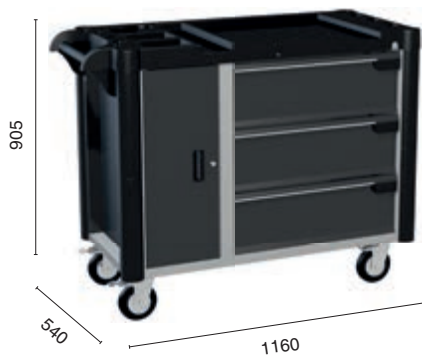

Central Key Lock

Dimensions HxWxD, mm
Large drawer – 3 pcs.:
198x554x469

Tool trolley WDS-5.1

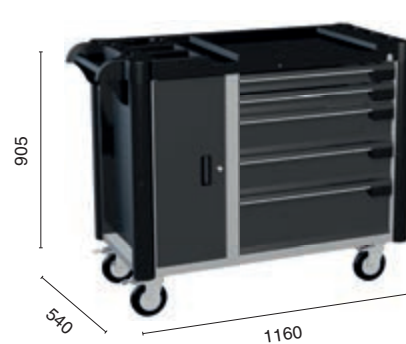

Central Key Lock

Dimensions HxWxD, mm:
Small drawer – 2 pcs.:
58x554x469
Medium drawer – 2 pcs.:
128x554x469
Large drawer – 1 pcs.:
198x554x469

Tool trolley WDS-6.1

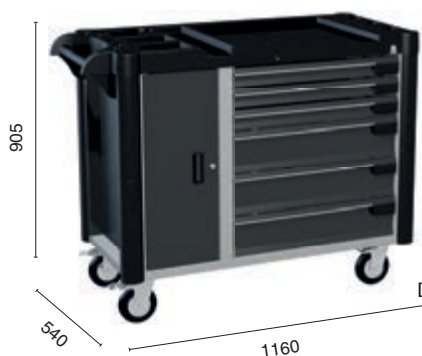

Central Key Lock

Dimensions HxWxD, mm:
Small drawer – 3 pcs.:
58x554x469
Medium drawer – 3 pcs.:
128x554x469

Tool trolley WDS-9.1

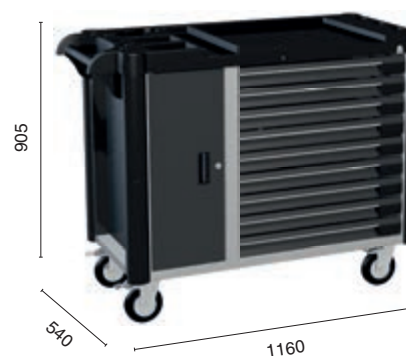

Central Key Lock

Dimensions HxWxD, mm:
Small drawer – 9 pcs.:
58x554x469



Tag holders with tool icons (included)
- for the organization of the 5S lean manufacturing system



The perforated walls of the trolley allow you to place various accessories on them (see page 32)

Additional options and accessories for workbenches and tool trolleys

Perforated panel WS 100/120/140/160/180/200

Steel 1,2 mm

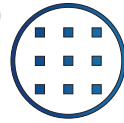
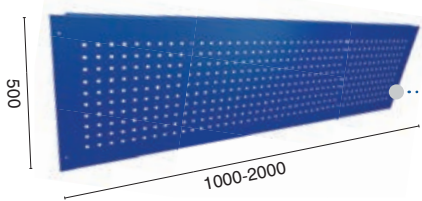

Square perforation
10x10 mm,
step 38mm

Set of triangles

for perforated panel WS
steel 1,2 mm

Dimensions HxWxD,
505x210x45



Light set W

Led light:
Voltage 220 V;
Power 11Wt;
Light output - 880 Lm;
Light temperature - 4000K;
Length - 835 mm.

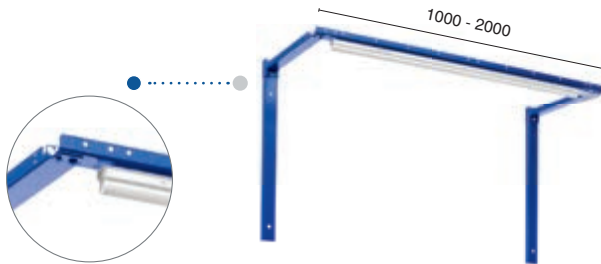

Brackets

for 2 perforated panels mounting
Steel 1,2 mm

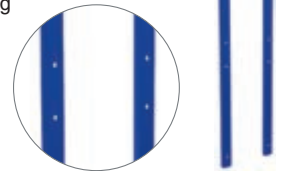

Wheel set



Non-rotatable – 2 pcs.



Rotatable – 1 pcs.



Rotatable with brake – 1 pcs.



Electric socket set

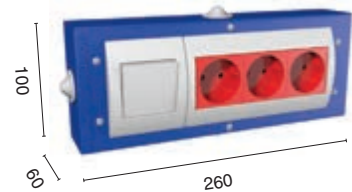

Perforated panel Accessories

SSh Small shelf

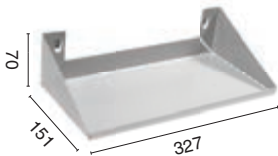

Lsh Large shelf

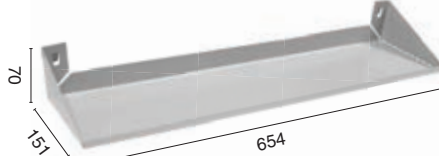

ScSh Spray can shelf

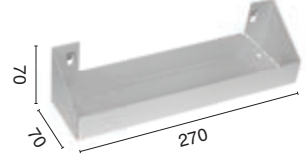

WH Wrench holder

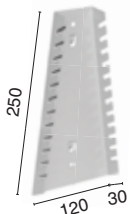

Paper tray

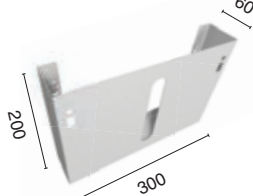

TH Tool holder

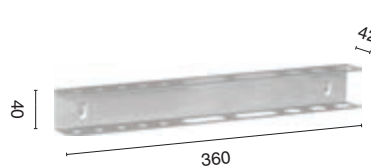

Towel holder

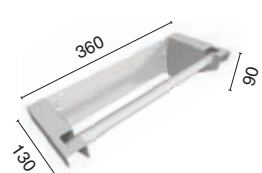

Plastic box holder

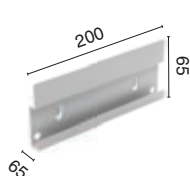

Holders for hex key and drill bits

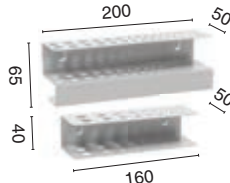

HK-4 Spring hook L = 5 cm



HK/HK-3 Hook L = 7 / 12 cm

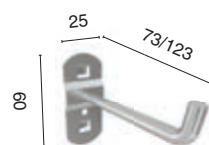

HK-5 Paper spring holder

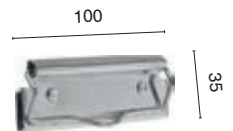

Additional options and accessories for workbenches and tool trolleys

Hardware storage plastic boxes

Promet
170x80x105



Promet
200x157x90



Promet
400x185x100

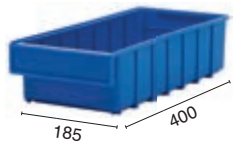

Promet
400x230x150



Promet
500x230x150



Profi WD

Cabinet

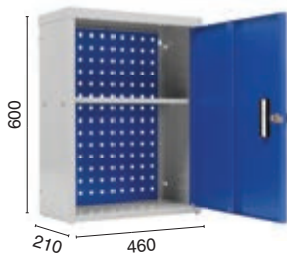

The cabinet can be mounted on the perforated panel or the wall. Equipped with a key lock and handle (2 keys included). Removable shelf. The possibility of changing the door opening side.

Perforated panel WS 60

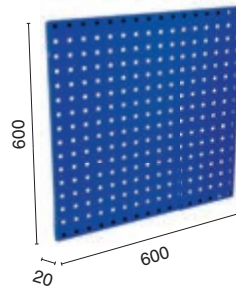

Perforated panel can be mounted in several ways:

- To the wall (fixtures included).
- Between two Profi WD cabinets by hooks.
- Connection between each other by hooks.

First aid kit for perforated panel WS

AMD-39

AMD-39 G

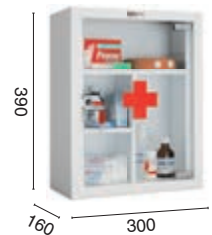
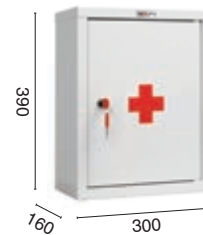

Can be fixed to the perforated panel using special fixtures (included).

Industrial (Laboratorium) chairs

Chair with armrests

Polyurethane seat and chair back, the height of the chair is adjustable. The backrest of the chairs is adjustable in height and angle of inclination, the foot support ring is height adjustable. Weight: 15 kg

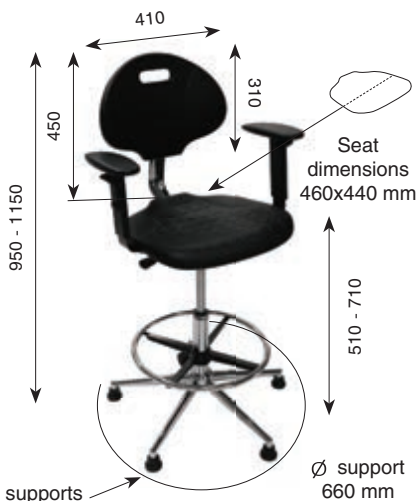

Wheelchair

Polyurethane seat and chair back, the height of the chair is adjustable, the backrest of the chair is adjustable in the angle of inclination. Weight: 10 kg



Wheel stool

Polyurethane seat, the height of the stool is adjustable. Weight: 5 kg

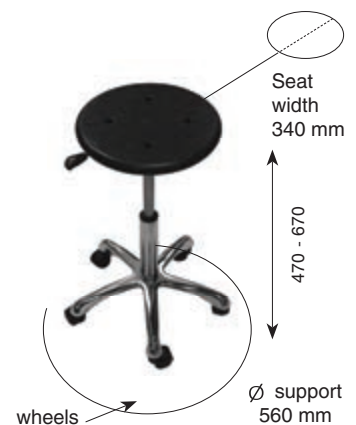

Tool cabinet **TC 1095**

Designed for secure storage of different instruments, hardware and spare parts at enterprises, workshops, private garages and auto service shops.

● **Colour:**  RAL 7038  RAL 5002

- Possibility to model the cabinet by selecting the necessary components and their location in the cabinet individually.
- Steel thickness is 0.8 mm.
- Locking bolts are made of galvanized steel and plastic bushings provide a silent door movement and reliable locking of the cabinet.
- Equipped with a convenient key lock with a handle (Cyberlock, 2000 combinations, 2 keys included).
- Two standard sizes of shelves in width; a wardrobe shelf; two standard sizes of drawers in height and width; three options of internal partitions to create an ergonomic space.
- Delivered disassembled.

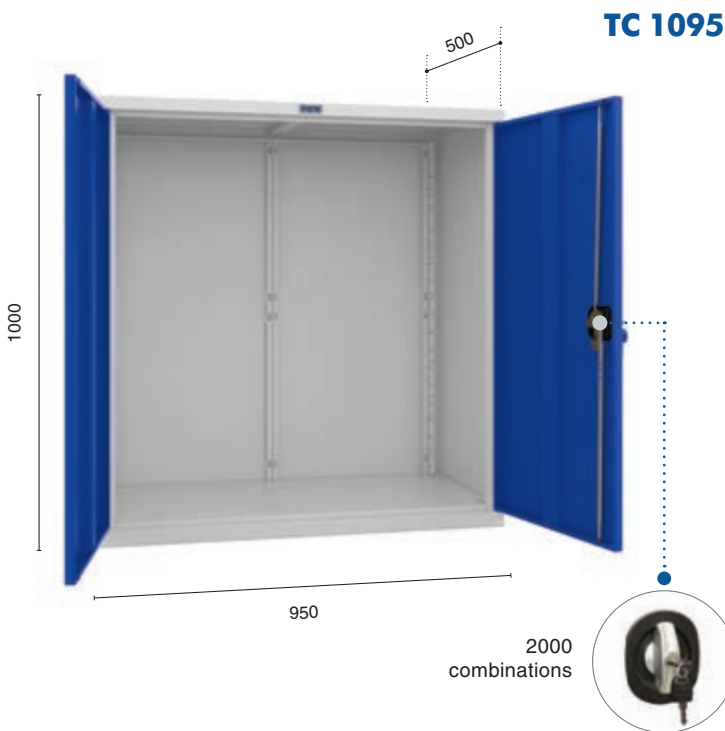
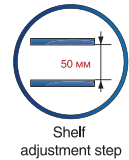

Small shelf TCSH 43x47

Large shelf TCSH 95x47

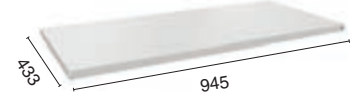
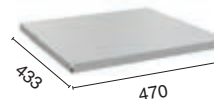

TCF 43x47 can be installed only if the partition TCD-1800 or TCD-900 used.

Small drawer TCF 42x45

(Max capacity 12 pcs.)

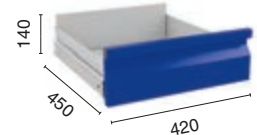

Large drawer TCF 87x45

(Max capacity 6 pcs.)

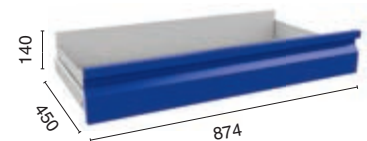

TCF 42x45 can be installed only if the partition TCD-1800, TCD-1800/2 or TCD-900 used.

Vertical partition

TCD 1800/2

TCD 900

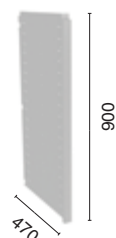
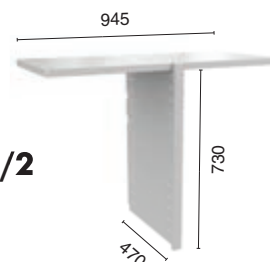

Perforated panel TCS 50x43

Square perforation: 10x10 mm

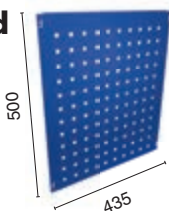

Plastic boxes for hardware storage



➕ **OPTION**

CNC shelves



SK-40*
(16 pcs.)



SK-50*
(12 pcs.)



HSK-63*
(16 pcs.)



* see p. 80

Ready sets of tool cabinets TC 1095



TC 1095-001010



TC 1095-021000



TC 1095-021010



TC 1095-021020



TC 1095-002020



TC 1095-001030



TC 1095-002000



TC 1095-002020



TC 1095-100302



TC 1095-100206



TC 1095-100215



TC 1095-1000010

⚠ Note: Filling of products in the form of tools, plastic containers, various items not related to steel furniture is not included in the package of serial products.

Tool cabinet TC 1995

Designed for secure storage of different instruments, hardware and spare parts at enterprises, workshops, private garages and auto service shops.

● **Colour:**  RAL 7038  RAL 5002

- Possibility to model the cabinet by selecting the necessary components and their location in the cabinet individually.
- Steel thickness is 0.8 mm.
- Locking bolts are made of galvanized steel and plastic bushings provide a silent door movement and reliable locking of the cabinet.
- Equipped with a convenient key lock with a handle (Cyberlock, 2000 combinations, 2 keys included).
- Two standard sizes of shelves in width; a wardrobe shelf; two standard sizes of drawers in height and width; three options of internal partitions to create an ergonomic space.
- Delivered disassembled.



TC 1995



2000 combinations



Max load per cabinet



Max load per shelf

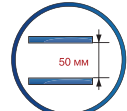

Shelf adjustment step



Max load per drawer



Max load per perforated panel



Ball bearing slides

Small shelf TCSH 43x47

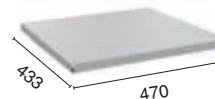

Large shelf TCSH 95x47

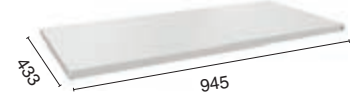

TCSH 43x47 can be installed only if the partition TCD-1800 or TCD-900 used.

Small drawer TCF 42x45

(Max capacity 24 pcs.)

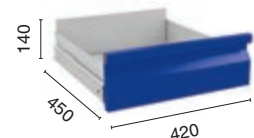

Large drawer TCF 87x45

(Max capacity 12 pcs.)

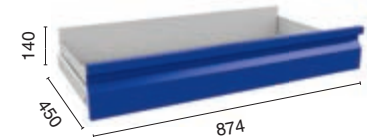

TCF 42x45 can be installed only if the partition TCD-1800, TCD-1800/2 or TCD-900 used.

Perforated panel TCS 50x43

Square perforation: 10x10 mm

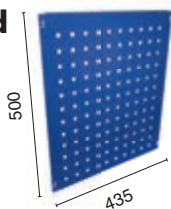

CNC shelves



SK-40* (16 pcs.)



SK-50* (12 pcs.)



HSK-63* (16 pcs.)



* see p. 80

Wardrobe kit TCSH

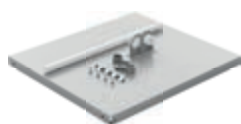

Load per shelf



Load per crossbar

⊕ **OPTION**

Vertical partition

TCD 1800/2

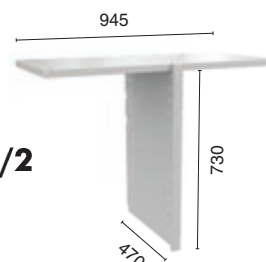

TCD 1800

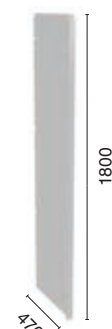

Ready sets of tool cabinets TC 1995



TC 1995-042000



TC 1995-042020



TC 1995-041030



TC 1995-041040



TC 1995-004010



TC 1995-004020



TC 1995-003040



TC 1995-100600



TC 1995-120402



TC 1995-1006010



TC 1995-121215



TC 1995 with CNC shelves

⚠ Note: Filling of products in the form of tools, plastic containers, various items not related to steel furniture is not included in the package of serial products.

Tool cabinet **TC 1995/2**

Designed for secure storage of different instruments, hardware and spare parts at enterprises, workshops, private garages and auto service shops.

● **Colour:**  RAL 7038  RAL 5002

- Possibility to model the cabinet by selecting the necessary components and their location in the cabinet individually.
- Steel thickness is 0.8 mm.
- Locking bolts are made of galvanized steel and plastic bushings provide a silent door movement and reliable locking of the cabinet.
- Equipped with a convenient key lock with a handle (Cyberlock, 2000 combinations, 2 keys included).
- Two standard sizes of shelves in width; two standard sizes of drawers in height and width; three options of internal partitions to create an ergonomic space.
- Delivered disassembled.

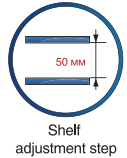

TC 1995/2



2000 combinations

**Small shelf
TCSH 43x47**

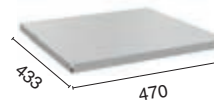

**Large shelf
TCSH 95x47**

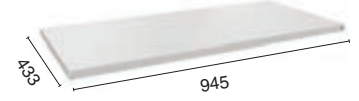

TCF 43x47 can be installed only if the partition TCD-1800 or TCD-900 used.

**Small drawer
TCF 42x45**

(Max capacity 24 pcs.)

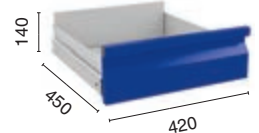

**Large drawer
TCF 87x45**

(Max capacity 12 pcs.)

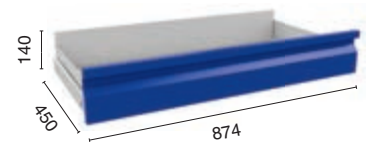

TCF 42x45 can be installed only if the partition TCD-1800, TCD-1800/2 or TCD-900 used.

Perforated panel TCS 50x43

Square perforation: 10x10 mm

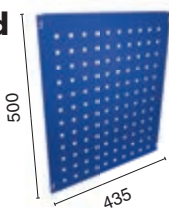

CNC shelves



SK-40*
(16 pcs.)



SK-50*
(12 pcs.)



HSK-63*
(16 pcs.)



* see p. 80

Vertical partition

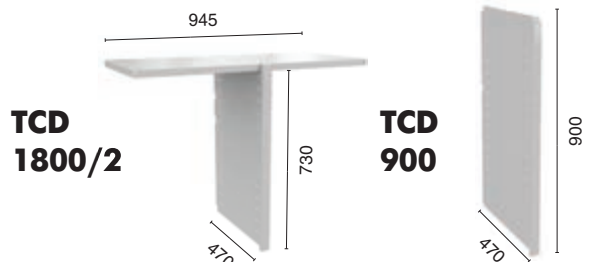

Ready sets of tool cabinets TC-1995/2



TC 1995/2-024010



TC 1995/2-022050



TC 1995/2-121215



TC 1995/2-102400



TC 1995/2-102215



TC 1995/2-1220110



TC 1995/2-102206



TC 1995/2-1020010



TC 1995/2-102200

! Note: Filling of products in the form of tools, plastic containers, various items not related to steel furniture is not included in the package of serial products.

Tool cabinet TC 1947

Designed for secure storage of different instruments, hardware and spare parts at enterprises, workshops, private garages and auto service shops.

● **Colour:**  RAL 7038  RAL 5002

- Possibility to model the cabinet by selecting the necessary components and their location in the cabinet individually.
- Steel thickness is 0.8 mm.
- Locking bolts are made of galvanized steel and plastic bushings provide a silent door movement and reliable locking of the cabinet.
- Equipped with a convenient key lock with a handle (Cyberlock, 2000 combinations, 2 keys included).
- The cabinet can also be used as a industrial locker, for storing and change of clothes, when used in the complete set-TSH wardrobe kit (GC).
- Delivered disassembled.

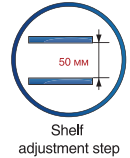

TC 1947



2000 combinations

**Small shelf
TCSH 43x47**

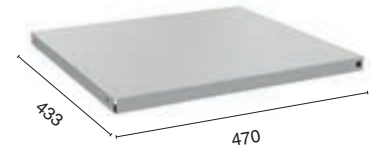

**Drawer
TCF 39x45**

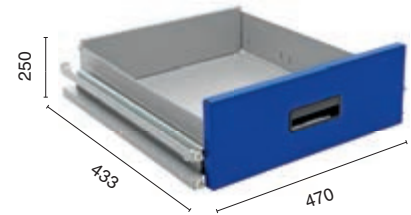

**Set of side perforated panels
Garage MS (2 pcs.)**

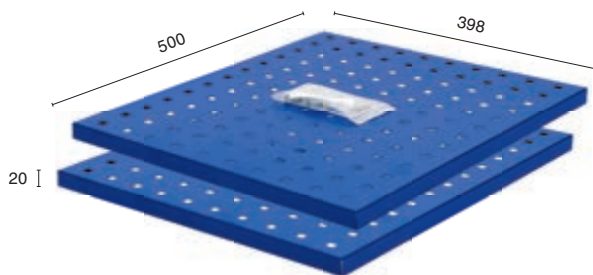

Can be installed as the back wall perforated panel in TC-1947

Wardrobe set TCSH



Two plastic hooks included

Ready sets of tool cabinets **TC-1947**



TC-1947 - 020202



TC-1947 - 020301



TC-1947 - 000202GK



TC-1947 - 000200GK



TC-1947 - 000400



TC-1947 - 000201GK



TC-1947 - 020300



TC-1947 - 000402



TC-1947 - 000305

⚠ Note: Filling of products in the form of tools, plastic containers, various items not related to steel furniture is not included in the package of serial products.

Heavy duty tool cabinet AMH TC

Designed for storage of instruments, hardware and heavy loads at different enterprises, workshops and factories.

● **Colour:**  RAL 7038  RAL 5002

- Fully welded body.
- Body and doors steel thickness – 1,5 mm.
- Possibility to model your own cabinet by using standard items for cabinet filling.
- Two types of drawers, drawer partitions, galvanized shelves.
- Forklift clearance included.
- Adjustable legs (max load 600 kg).
- Delivered assembled.

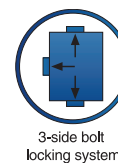

Forklift clearance:

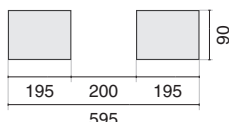

Reliable safe locks Kaba Mauer (Germany) Class A

Electronic Lock PS310/E31 Class B

Drawer AMH TC 60

Max capacity 26 pcs.

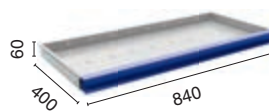

Drawer AMH TC 125

Max capacity 13 pcs.

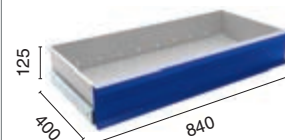

Drawer adjustment step - 64 mm.

Shelf AMH TC

Galvanized

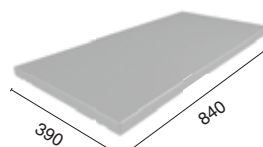

Drawer partitions set



Shelf adjustment step - 32 mm.

CNC shelves AMH TC



SK-40*
(11 pcs.)



SK-50*
(6 pcs.)



HSK-63*
(11 pcs.)

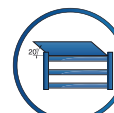

* see p. 80

Set of perforated panels AMH TC



10x10 mm step 38 mm



Ready sets of tool cabinets **AMH TC**



AMH TC-004000



AMH TC-004010



AMH TC-062000



AMH TC-005020



AMH TC-003040



AMH TC-062030



AMH TC-062032



AMH TC-003000CNC



AMH TC-004000CNC

Heavy duty modular tool cabinets **HARD**

Designed for storage of instruments, hardware and heavy loads at different enterprises, workshops and factories.

● **Colour:**  RAL 7038  RAL 5002

- The cabinet design is dismantlable. The basis of the design consists of two frames (vertical MS PRO racks made of galvanized steel, diagonal and horizontal ties). The side panels are attached to the frames (side and rear walls, floor and roof, metal doors).
- Door thickness – 1.2 mm.
- Possibility to model your own cabinet by using standard items for cabinet filling.
- Three standard sizes of different heights; sets of partitions for drawers for organizing an ergonomic space; two types of shelves for storing tools; a pull-out shelf, shelves for CNC tools.
- Equipped with a reliable key lock Kaba Mauer (Germany), class A.
- Delivered disassembled.

Dismountable structure*



Ball bearing slides



2-side bolt locking system

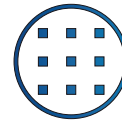

10x10 mm step 38 mm



HARD 1000

Max capacity:

Drawer HARD 60 – 10 pcs.

Drawer HARD 125 – 5 pcs.

Drawers HARD 265 – 2 pcs. + 1 pc. 125 or 2 pcs. 60

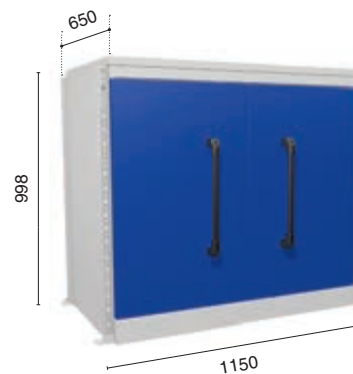

HARD 2000

Max capacity:

Drawer HARD 60 – 23 pcs.

Drawer HARD 125 – 11 pcs. + 1 pcs. 60

Drawer HARD 265 – 5 pcs. + 3 pcs. 60 or 1 pc. 125 + 1 pc. 60



! * When ordering tool cabinet Hard, you only need to order two Hard 1000 frames or two Hard 2000 frames and the corresponding housing. The housing kit includes: side and rear walls, floor, roof and doors, a set of fasteners.

Options for tool cabinet **HARD**

Shelves

Shelf HARD

Galvanized steel

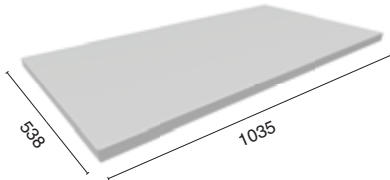

Max load per shelf

Pull-out shelf HARD

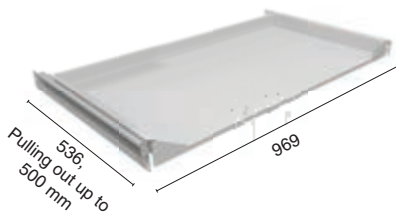

Max load per shelf



Ball bearing slides

CNC shelves



Max load per shelf

Dimensions HxWxD, mm:
30x1030x17

* see p. 80



Set of brackets for 3 shelves for CNC tools installation



Max load per brackets



Shelves are installed at an angle of 20°



Tabletop for Hard 1000

(only on request)



Max load



Plywood 30 mm

Drawers



Max load per drawer



Ball bearing slides

Drawer HARD 60

Dimensions HxWxD, mm:
125x970x460
max capacity:
HARD 1000 – 10 pcs.
HARD 2000 – 23 pcs.

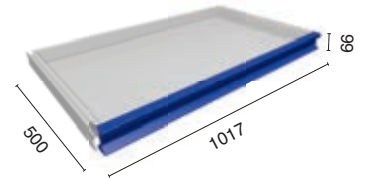

Set of partitions HARD 60

8 longitudinal and 2 transverse partitions included

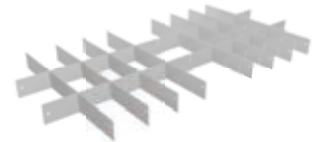

Drawer HARD 125

Dimensions HxWxD, mm:
125x970x460
max capacity:
HARD 1000 – 5 pcs.
HARD 2000 – 12 pcs.

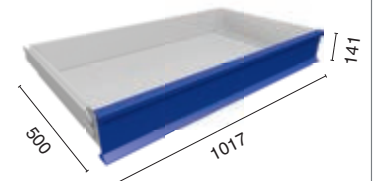

Set of partitions HARD 125

8 longitudinal and 2 transverse partitions included



Drawer HARD 265

Dimensions HxWxD, mm:
275x970x460
max capacity:
HARD 1000 – 2 pcs.
HARD 2000 – 5 pcs.

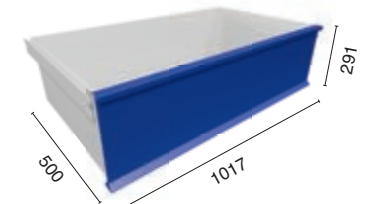

Perforated panel

Max load per panel 20 kg
Dimensions HxWxD, mm: 149x1037x26

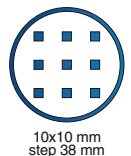

10x10 mm step 38 mm



Ready sets of tool cabinets **HARD 1000**



Hard 1000 - 000000



Hard 1000 - 002010



Hard 1000 - 001010



Hard 1000 - 021010



with CNC shelves

Hard 1000



Hard 1000 - 021030



Hard 1000 - 002030



with tabletop

Hard 1000 - 002001



Hard 1000 - 000021



Hard 1000 - 020000



Hard 1000 - 021000



Hard 1000 - 021020

Ready sets of tool cabinets **HARD 2000**



Hard 2000 - 000000



Hard 2000 - 004001



Hard 2000 - 004011



Hard 2000 - 004012



Hard 2000 - 033001



Hard 2000 - 033011



Hard 2000 - 023012



Hard 2000 - 023013



Hard 2000 with CNC shelves



Hard 2000 - 062012



Hard 2000 - 062000



Hard 2000 - 062011

PROMET PROFI

PROFESSIONAL CHOICE



TOOL AND INVENTORY STORAGE SYSTEMS

Tool and inventory storage systems are comfortable dismantlable structures which allows to organize the working space and to provide quick access to the necessary items.



- **Colour:**  RAL 7038  RAL 5002  Galvanized steel

- Dismountable structure. As the base the racks MS-pro and elements of cabinet HARD are used.
- The main feature is extremely fast assembly and reliability of module components.
- The racks are made of galvanized steel profile with the possibility of adjusting the heights of the shelves, tiers, as well as drawers. This makes it easy to place boxes and objects of various sizes, car wheels, and so on.
- The flooring of the tiers is metal shelves made of galvanized steel. Shelves are installed on beams
- The ability to install an unlimited number of sections in line
- The ability to model an individual workplace based on personal wishes and preferences
- Possibility of floor anchoring
- Delivered disassembled



TOOL STORAGE SET

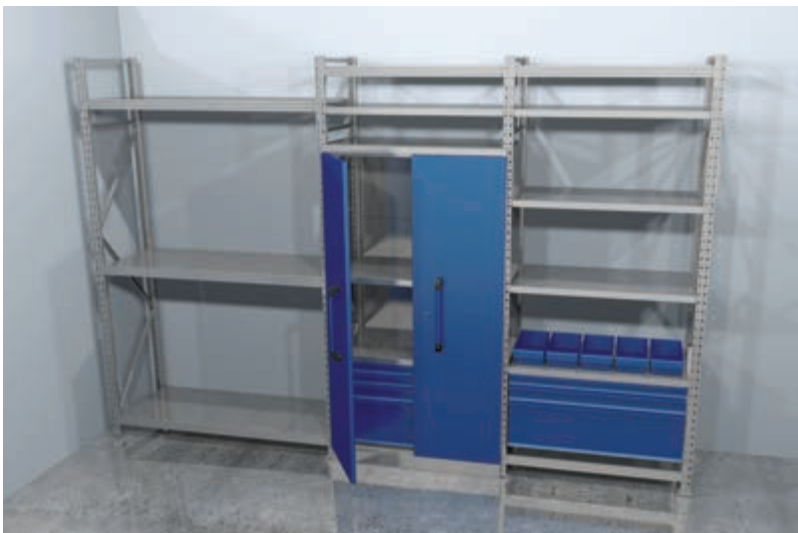

Dimensions HxWxD, mm: 2500x3912 (1612+1150+1150)x600 mm. Weight 297 kg.

- **400 kg**
Max load per shelf
- **2000 kg**
Max load per cabinet
- **80 kg**
Max load per drawer
- **500 kg**
Max distributed load per shelving level

PIKING

NAME	Q-TY, PCS.
Cabinet body HARD 2000	1
Shelf HARD	7
Drawer HARD 60	3
Drawer HARD 125	2
Drawer HARD 265	2
Perforated panel for cabinet HARD	3
Beam MS Pro 100 Z	6
Beam MS Pro 150 Z	6
Shelf MS Pro 60x15	10x3=30
Frame Profi MS 250x60	4
Set of partitions HARD 60	1
Set of partitions HARD 125	1

TOOL STORAGE SET WITH WORKING PLACE



Dimensions HxWxD, mm: 2500x3912 (1612+1150+1150)x600 mm. Weight 275 kg.

- **400 kg**
Max load per shelf
- **1000 kg**
Max load per cabinet
- **80 kg**
Max load per drawer
- **500 kg**
Max distributed load per shelving level

PIKING

NAME	Q-TY, PCS.
Cabinet body HARD 1000	1
Shelf HARD	6
Drawer HARD 60	1
Drawer HARD 125	1
Drawer HARD 265	3
Perforated panel for cabinet HARD	4
Beam MS Pro 100 Z	6
Beam MS Pro 150 Z	6
Shelf MS Pro 60x15	10x2=20
Frame Profi MS 200x60	4
Set of partitions HARD 60	1
Set of partitions HARD 125	1
Tabletop Hard 1000	1
Tire storage cover MS PRO 150	2

TOOL AND INVENTORY STORAGE SYSTEMS

GARAGE TOOL AND INVENTORY STORAGE SYSTEM



Dimensions HxWxD, mm: 2000x3912 (1612+1150+1150) x 603 mm. Weight 297 kg.



PIKING

NAME	Q-TY, PCS.
Frame Profi MS 200x60	4
Shelf HARD	7
Beam MS Pro 150 Z	6
Shelf MS Pro 60x15	10x2=20
Drawer HARD 60	2
Set of partitions HARD 60	1
Drawer HARD 125	2
Set of partitions HARD 125	1
Drawer HARD 265	3
Perforated panel for cabinet HARD	8
Beam MS Pro 100	8
Body HARD 1000	1
Frame HARD 1000	2
Tabletop HARD 1000	1
Perforated panel WS-60	3

Options for storage systems

Dismountable Frame

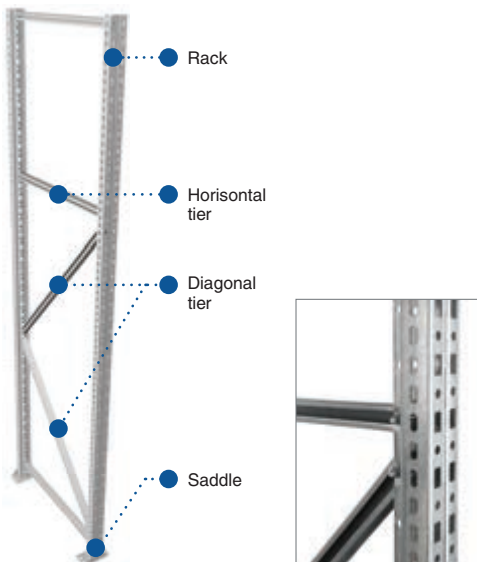

Rack

Stand made of galvanized steel profile 56x47 mm. Perforation step 50 mm.

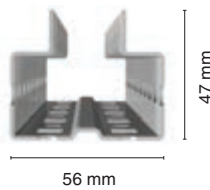

Saddle

Fixed to the rack via bolt M8. Holes for anchoring



Shelf

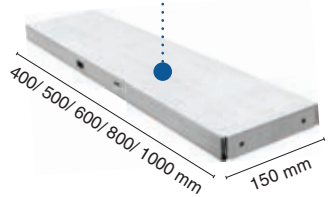
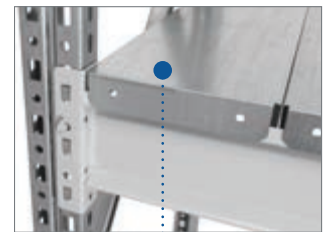

Shelves are installed on beams

Hardware storage plastic boxes

Promet
170x80x105



Promet
200x157x90



Promet
400x185x100

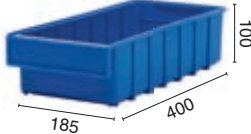

Promet
400x230x150



Promet
500x230x150



Options for storage systems

Cabinet HARD 1000



Max load

Max capacity:

Drawer HARD 60 – 10 pcs.

Drawer HARD 125 – 5 pcs.

Drawer HARD 265 – 2 pcs.
+ 1 pcs. 125 or 2 pcs. 60

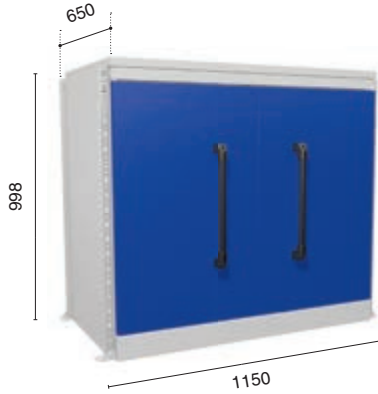

Cabinet HARD 2000



Max load

Max capacity:

Drawer HARD 60 – 23 pcs.

Drawer HARD 125 – 11 pcs.
+ 1 pcs. 60

Drawer HARD 265 – 5 pcs
+ 3 pcs. 60 or 1 pcs. 125
+ 1 pcs. 60



Tabletop for cabinet HARD 1000

Plywood 30 mm



Max load



(on request only)

Perforated panel

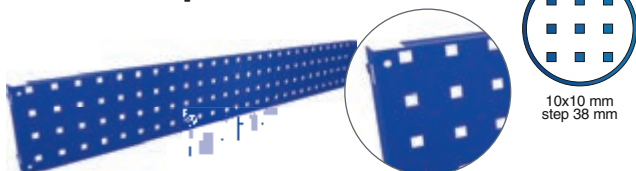

10x10 mm
step 38 mm

Max load per panel 20 kg. Dimensions HxWxD, mm: 149x1037x26

Shelves and Drawers

Shelf HARD

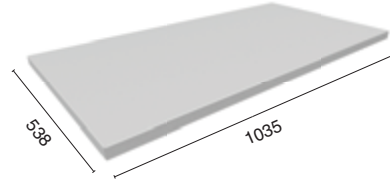

Max load per shelf

Galvanized steel

Pull-out shelf HARD

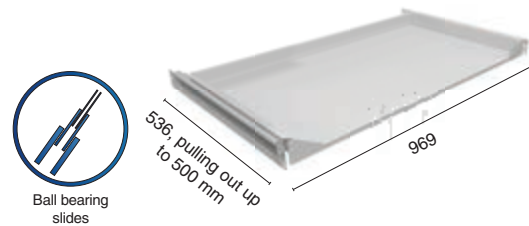

Ball bearing slides



Max load per shelf

CNC shelves

HARD SK-50 8 pcs.

HARD SK-40 10 pcs.

HARD HSK-63 10 pcs.



Max load per shelf

Dimensions HxWxD, mm: 30x1030x17

DRAWERS



Ball bearing slides



Max load per shelf

Drawer HARD 60 Set of partitions for drawer HARD 60

Dimensions HxWxD, mm:

125x970x460

Max capacity:

HARD 1000 – 10 pcs.

HARD 2000 – 23 pcs.

Drawer HARD 125 Set of partitions for drawer HARD 125

Dimensions HxWxD, mm:

125x970x460

Max capacity:

HARD 1000 – 5 pcs.

HARD 2000 – 12 pcs.

Drawer HARD 265

Dimensions HxWxD, mm:

275x970x460

Max capacity:

HARD 1000 – 2 pcs.

HARD 2000 – 5 pcs.

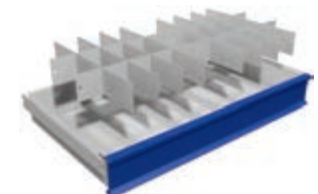
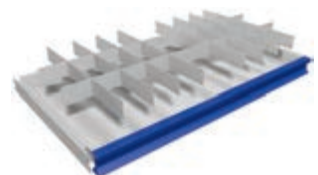

TOOL STAND Profi



Designed for quick and convenient access to tools and components in factories, workshops and garages. It is also often used in the 5S lean manufacturing system, when organizing workplaces.

● **Colour:**  RAL 7038  RAL 5002

- Fast and easy assembly.
- Max load 200 kg (50 kg for each perforated panel).
- Possibility to design modules using common frame.
- Possibility to install wheels or saddles for anchoring to the floor.
- Adjustable supports are included.
- The stand can be equipped with boxes for hardware, accessories for the perforated panel and a shelf MS Standart.
- Anchor holes for wall mounting.
- Delivered disassembled.

! What is needed to assemble the STAND



Frame for tool stand Profi



Square pipe 40x60 mm, steel thickness 2 mm. Installed using adjustable supports. Dimensions: 2000x500 mm.

Shelf MS Standart

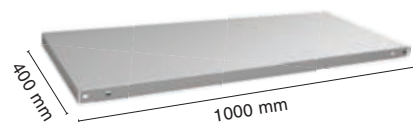

Max load per shelf

+ OPTION

A shelf can be installed on the base of the Profi frame

Perforated panel WS 100

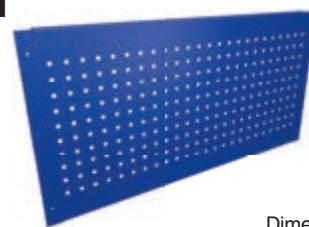

Max load per panel

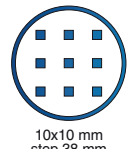

10x10 mm step 38 mm

Steel 1,2 mm

Dimensions HxWxD, mm 500x1000

Box holder

For plastic boxes

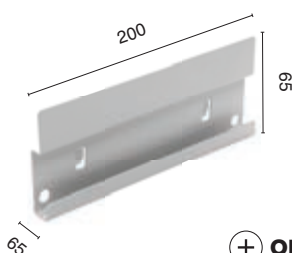

+ OPTION

Plastic boxes for hardware

+ OPTION

- Promet** 170x80x105
- Promet** 200x157x90
- Promet** 400x185x100
- Promet** 400x230x150
- Promet** 500x230x150

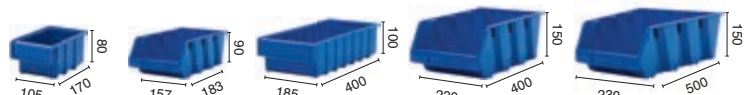

Drying cabinets



Construction sites



Schools and kindergartens

Winter sport facilities



Oil drilling and refineries

DRYING CABINETS **DC series**

Drying cabinets are designed for drying wet clothes, shoes, sports uniforms, work clothes and professional uniforms.

The principles of operation is the heated air circulation inside the cabinet.
Used at construction sites, drilling and oil refineries, firefighters, industrial premises, military units, maintenance crews, marine crews, ski facilities, kindergartens, schools, private houses etc.

● **Colour:**  RAL 7038

- Long service life. The heating element is located in the upper part, which prevents water from entering the electrical elements.
- Easy to operate. The temperature and drying time are adjusted by two regulators. There is an indicator of the end time of work. Any untrained person can cope.
- The flange is included.
- Delivered disassembled (two boxes).

ADVANTAGES:



SAFETY

All electronics are on top. RCD is out of the cabinet on the top.



DRIES EVEN VERY WET CLOTHES

The fan with a capacity of 2500 W and an air flow of 180 m³/h allow you to dry not only lightly wet clothes but also very wet things



RIGID STRUCTURE

Thanks for use of patented system, the rigidity of the body is comparable and even exceeds similar parameters al fully-welded cabinets.



RELIABLE KEY-LOCK

Key lock with two sided bolt locking system (2000 combinations)



CAPACITY

The cabinets depth allows to dry bulky clothes including winter jackets and coats



Max load per crossbar

Flange
Ø 125 mm
(included)



Max load per shelf

● Net-type shelves

Allows the air to circulate better to speed up drying

● Galvanized bottom

Set of heat-resistant rubber trays DC



Dimensions (1pc.) mm:
 Cyclone1965: 290x530x25
 Cyclone1985: 390x530x25
 Breeze 1940: 390x430x25

+ OPTION

DC Cyclone 1965 / DC Cyclone 1985

Used at construction sites, drilling and oil refineries, firefighters, industrial premises, military units, maintenance crews, marine crews, ski facilities, kindergartens, schools, private house etc.

● **Colour:**  RAL 7038

- Dry not only wet, but also very wet things. Cabinets are safe to use - drops of water will not fall on the heating elements, as all electronics are in the upper part, the RCD is placed on the cabinet body.
- Easily controlled by two regulators – drying time and temperature (up to 70°C).
- If necessary, the cabinet can be connected to the exhaust ventilation system, flange included.
- Cabinets are equipped with removable net shelves and crossbar for hangers. Outerwear, shoes, gloves etc. can be placed on the shelves and due to perfect air circulation will be dried faster.
- Corrosion proof. The bottom is galvanized.
- Option: additional net, wire shelves, set of heat resistant rubber trays
- Delivered disassembled (two boxes).



Rigid body



Safety 2000 combinations

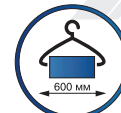

Capacity



Extra safety



Max load per shelf



Corrosion resistant

DC Cyclone 1965



* Height without flange



DC Cyclone 1985



* Height without flange

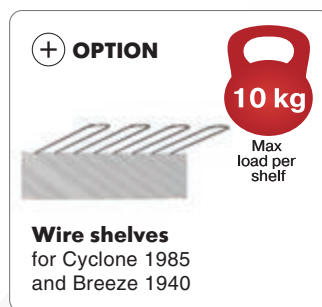
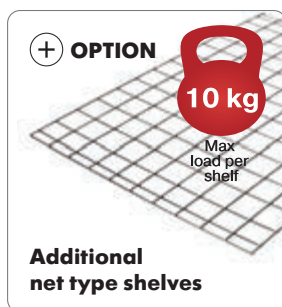
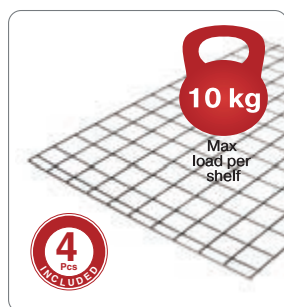

Technical data

Installation type	Independent	Voltage, V	220
Type of drier	Heated ventilation	Power input, Wt.	2180
Controller type	Mechanical	Frequency, Hz	50
Drying time:	Timer (up to 4 hours)	Heating elements power, Wt	2x1050
Max air temperature	up to 70°C	Fan capacity, m ³ /hour	180
Time indication	Timer bar	Noise level, Db.	45
Crossbar	1	Cable length, cm	400+-100

DC Breeze 1940

Children's drying cabinet is the best solution for children's institutions sports schools and fitness centers.

Used at pre-school institutions, for drying wet clothes, shoes, gloves, scarfs. All clothes and shoes are placed on the wire type shelves

- Easily controlled by two regulators – drying time and temperature (up to 70°C).
- Can be connected to external ventilation system via flange 125mm (included).
- Corrosion proof. The bottom is galvanized.
- In addition can be equipped with net type, wire shelves, set of heat resistant rubber trays or special set Breeze 1940.
- Delivered disassembled without shelves(two boxes).



Rigid body



Extra safety



Safety 2000 combinations



Corrosion resistant

• **Colour:**  RAL 7038

• **Possible door colour:**  RAL 6018  RAL 2008 **+ OPTION**

 RAL 9003  RAL 5002

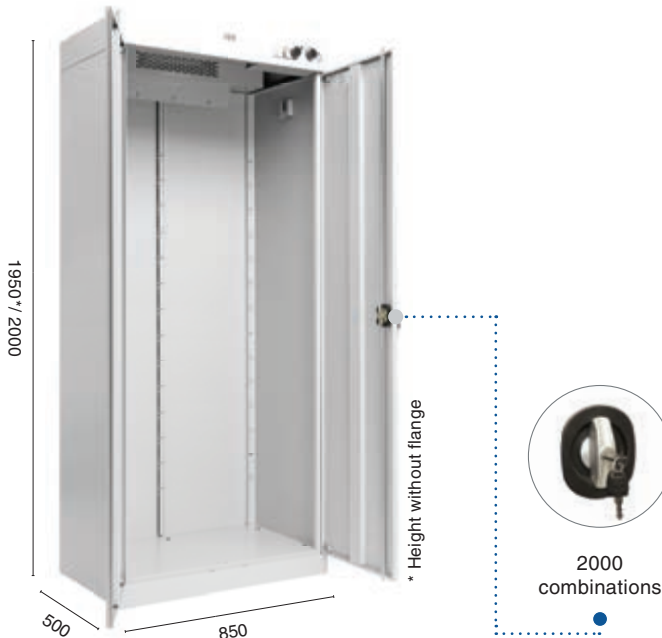

- DC BreeZe 1940
- Set DC 1940
- Wire type shelves 5 pcs.

Set DC 1940

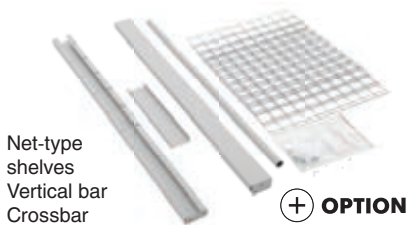

Net-type shelves
Vertical bar
Crossbar

+ OPTION

Wire-type shelves



+ OPTION



Set of rubber trays DC

Heat-resistant



Dimensions (1pc.) mm:
Breeze 1940: 390x430x25

+ OPTION

Technical characters

Installation type	Independant	Voltage, V	220
Type of dryer	Heated ventilation	Power input, Wt.	2180
Controller type	Mechanical	Frequency, Hz	50
Drying time	Timer (up to 4 hours)	Heating elements power, Wt	2x1050
Max air temperature	up to 70°C	Fan capacity, m³/hour	180
Time indication	Timer bar	Noise level, Db.	45
Crossbar	1	Cable length, cm	400+-100

Drying rack NORTH

Drying rack is designed for drying of footwear. Used at construction site, fitness centers, ski and skate facilities.

- **Colour:**  RAL 7038  RAL 7024

The principle of operation is to pump warm air into the shoes through the tube brackets. Wet shoes are placed on brackets located on the rack, through which warm air is supplied. Thus, air convection occurs directly inside the shoe, which significantly accelerates the drying process. Each shoe nozzle is equipped with an inertial valve, which blocks the air flow if the shoe is not put.

- Rigid fully welded structure.
- The bactericidal UV- lamp disinfects shoes and helps to eliminate unpleasant odors. It is located in the upper part of the rack.
- For convenient transportation the rack is equipped with rubber wheels d=75mm (all rotatable, 2 with brakes).
- Delivered disassembled (2 boxes).



Rigid body



Extra safety



Wheels included



75 MM
Wheels diameter



Corrosion resistant

NORTH 16 (16 shoes pairs)

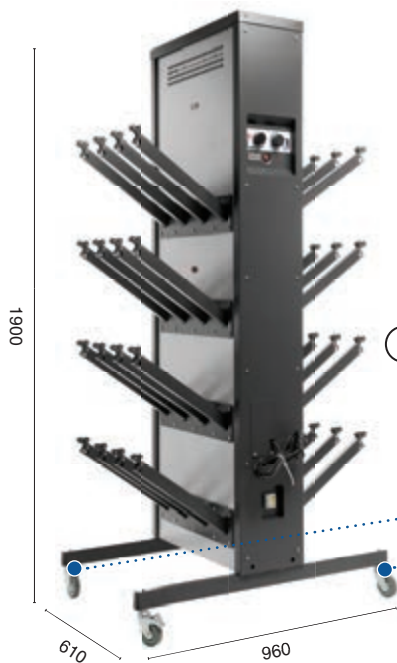

NORTH 20 (20 shoes pairs)

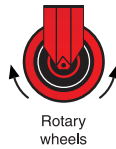

Rotary wheels



Rotary wheels with brake



Each shoe nozzle is equipped with an inertial valve, which blocks the air supply if the shoe is not put.

Technical characters

Installation type	Independant	Voltage, V	220
Drying type	Heated ventilation	Power input, Wt.	Max 2680
Controller type	Mechanical	Frequency, Hz	50
Drying time	Timer (4 hours)	Heating elements power, Wt	Max 2260
Max air temperature	up to 40°C	Fan capacity, m³/hour	360x2
Numper of nozzles, pcs.	32/40, internal D=27±2mm	Noise level, Db.	45
Bactericidal UV-lamp	Lamp power - 15Wt.	Cable length, cm	400+-100



NEW DESIGN OF TUBE WITH VALVE.
Each shoe ware bracket is equipped with inertial valve,
which blocks the air flow if the shoe is not put.

DC Sakhara

Sakhara drying cabinet are optimal for drying uniforms of a whole group of workers: firefighters, builders, military, people who are constantly on the street. Used on rig and oil stations, paramilitary units, maintenance crews.

● **Colour:**  RAL 7038

Used on rigs and oil stations, paramilitary units, maintenance crews.

- The cabinet consists of two independent cabinets 1. Two-door for clothes, with a crossbar for hangers and a shelf.
- 2. For drying footwear, equipped with tube brackets.
- Safety. All electronics are located in the upper part, the RCD is placed on the cabinet body.
- Controlled by two regulators a timer for 6 hours and a drying temperature of up to 70°C, for shoes up to 40°C.
- The 600 mm depth allows you to dry bulky things, including overalls and winter jackets.
- Corrosion resistant. Galvanized bottom, rubber trays included.
- Adjustable supports.
- Possibility to connect to external ventilation system. Flange d=125mm included.
- Delivered disassembled.



Rigid body



Extra safety



Safety 2000 combinations



Capacity



Corrosion resistant

Sakhara 5

Two independent cabinets 1. Two-door for clothes, with a crossbar for hangers and a shelf, capacity of 5 sets of clothes. 2. For drying shoe-ware, equipped with tube brackets, capacity of 6 pairs of shoes. Cross bar, net-type shelf, flange, set of heat resistant rubber trays (3 pcs.)



Sakhara 8

Two independent cabinets 1. Two-door for clothes, with a crossbar for hangers and a shelf, capacity of 8 sets of clothes. 2. For drying shoe-ware, equipped with tube brackets, capacity of 8 pairs of shoes. Cross bar, net-type shelf, flange, set of heat resistant rubber trays (4 pcs.)



Each shoe ware bracket is equipped with inertial valve, which blocks the air flow if the shoe is not put.
 Dimensions (1 pcs.) mm:
 Cyclone 1965: 290x530x25
 Cyclone 1985: 390x530x25
 Breeze 1940: 390x430x25

Set of heat resistant rubber trays DC

included, dimensions W x D: 390x530 mm

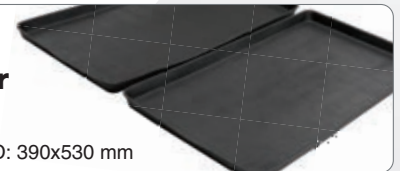

Technical characters

Installation type	Independent	Bactericidal UV-lamp	-
Drying type	Heated ventilation	Voltage, V	220
Controller type	Mechanical	Electricity consumption, Wt.	2x2180
Drying time	Timer (up to 6 hours)	Frequency, Hz.	50
Max drying temperature	up to 70°C	Heating elements power per cabinet, Wt.	2x1050
Number of shelves, pcs.	1	Fan capacity, m³/hour	2x360
Max load per shelf, kg	10	Noise level, Db.	not more than 46
Crossbar	1	Cable length, cm	400+-100

PROMET PROFI

PROFESSIONAL CHOICE

MS Pro



MEDIUM-LOAD RACKS **MS Pro**

Designed for use in warehouses and industries, also can be used in small areas – garages, retail outlets, storerooms

● **Beam colour:**  RAL 7038  Galvanized steel

Possibility to change the colour according RAL (see p. 54)
* All elements are made of galvanized steel, except beams

- Medium-load shelving is easily assembled structure, which consists of vertical frames, fixed to them horizontal beams and installed shelves
- Delivered disassembled



TWO FRAME TYPES

Expert

Stand thickness 1,5 mm



Max load per rack

Profi MS

Stand thickness 1,2 mm



Max load per rack

LEVEL

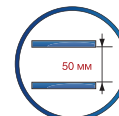

Level adjustment step



Max load per level

BEAM

Welded, painted

* Load 400 kg

Saddle



Saddle with anchoring hole

Attached to the stand using M8 bolts

NEW

Beam fixing without bolts

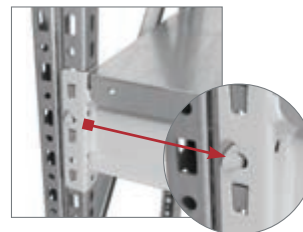

On hooks

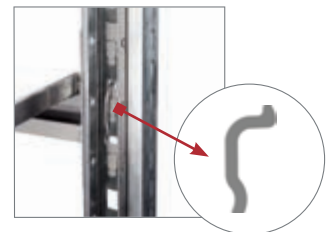

Beam lock

! ATTENTION:

MAX DISTRIBUTED LOAD PER LEVEL



Options for shelving **MS Pro**

Dismountable frame

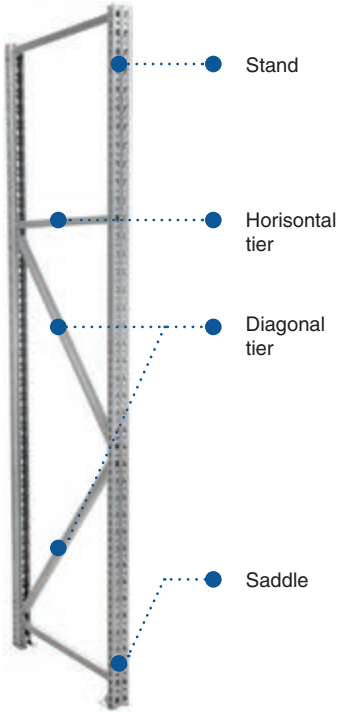

The design of the frame is dismountable. The frame – consists of two vertical stands connected by horizontal and diagonal tiers.

Stand

Made of galvanized steel perforated profile 56x47 mm. Perforation step - 50 mm.

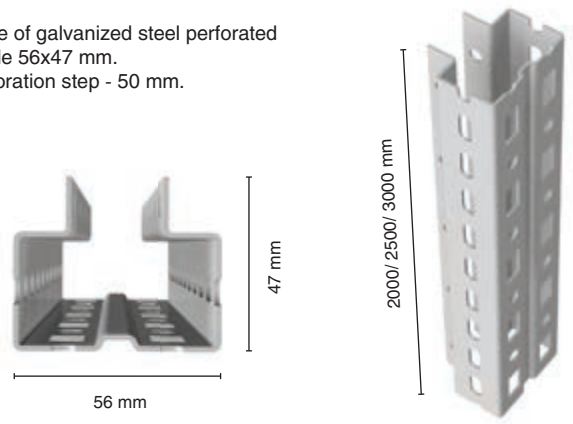

Saddle



Saddle with anchoring hole. Attached to the stand using M8 bolts

Frame assembly step-by-step

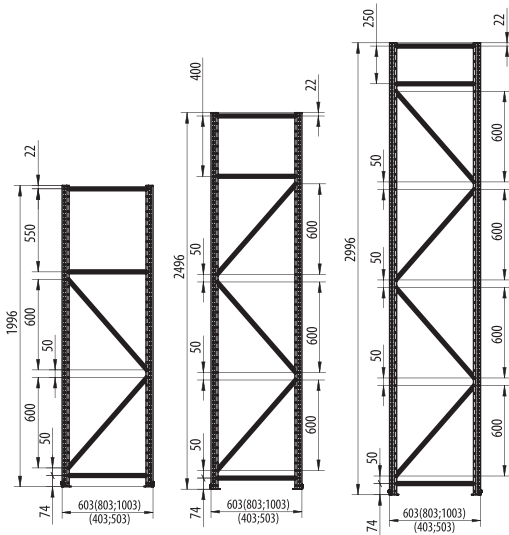

* Beam height 3000 mm on request

Perforated panel WS MS Pro

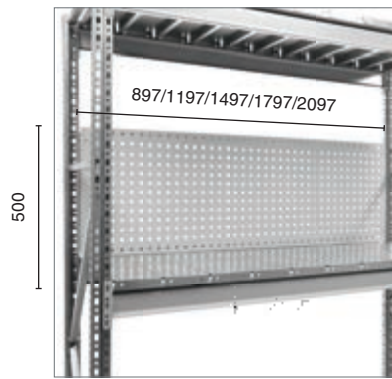

+ OPTION

Installed on the rack MS Pro as a back wall width 900/1200/1500/1800/2100 mm

Side perforated panel WS MS Pro

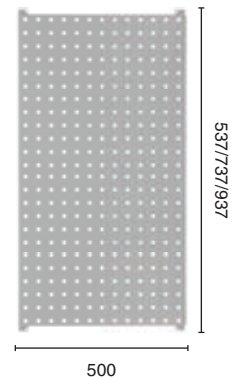

+ OPTION

Installed on the rack MS Pro as a side wall Depth 600/800/1000 mm

SET OF STANDS	Q-TY OF STANDS, PCS.	SADLE MS PRO, PCS.	MOUNTING KITS, PCS.
Set of stands Profi 200 \ Set of stands Expert 200	2	2	5
Set of stands Profi 250 \ Set of stands Expert 250			6
Set of stands Profi 300 \ Set of stands Expert 300			7
SET OF TIERS	HORISONTAL TIER, PCS.		DIAGONAL TIERS, PCS.
Set of tiers MS Pro 200x40/50/60/80/100	3		2
Set of tiers MS Pro 250x40/50/60/80/100	3		3
Set of tiers MS Pro 300x40/50/60/80/100	3		4

Options for shelving **MS Pro**

Welded beam **NEW**

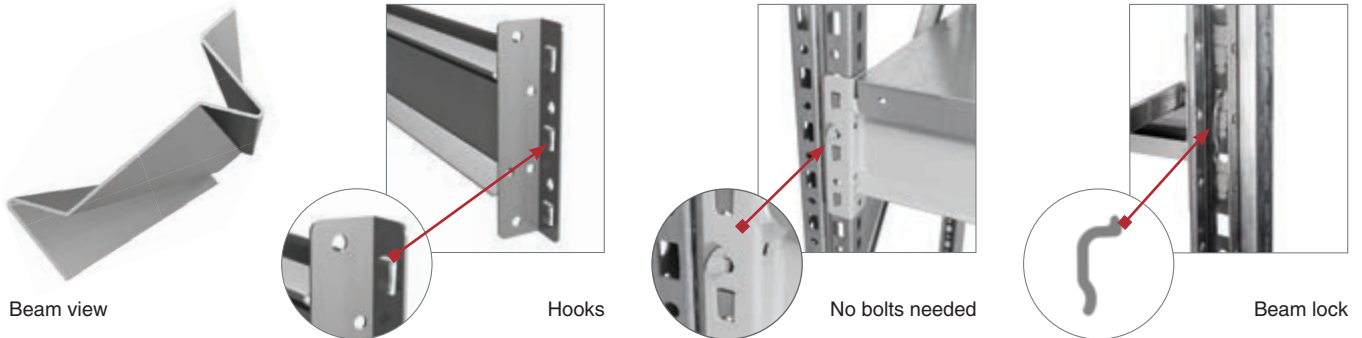

LEVEL SHELVES

The beam design gives the possibility to use 3 types of shelves: Galvanized shelves, net-type shelves, MDF or Plywood board shelves - 16 mm.

Level shelf MS Pro Z (Galvanized steel)

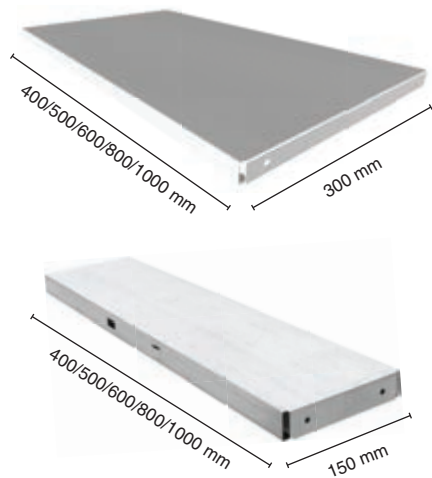

Level options



Steel net-type shelf

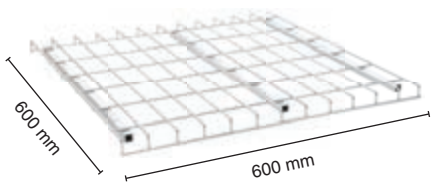

MDF and plywood boards can be used as level shelves

NAME	Q-TY OF BEAMS MS PRO Z PER LEVEL, PCS	LEVEL SHELF MS PRO Z, PCS. (WIDTH 150 OR 300 MM)		
		60X15/30	80X15/30	100X15/30
Level MS Pro 90x60/80/100	2	6/3	6/3	6/3
Level MS Pro 120x60/80/100	2	8/4	8/4	8/4
Level MS Pro 150x60/80/100	2	10/5	10/5	10/5
Level MS Pro 180x60/80/100	2	12/6	12/6	12/6
Level MS Pro 210x60/80/100	2	14/7	14/7	14/7
Beam lock	2 pcs. included to 1 beam			

Ready sets of shelving MS Pro

■ Shelving MS Pro (sets)



MS Pro 200/150x60/4



MS Pro 200/180x60/4



MS Pro 250/150x60/5



MS Pro 300/150x80/5

■ Additional shelving for common rack



MS Pro 200/150x60/4



MS Pro 200/180x60/4



MS Pro 250/150x60/5



MS Pro 300/150x80/5

Shelving MS Pro sets

MODEL	HIGHT, MM	WIDTH, MM	DEPTH, MM	LEVELS NUMBER	PIKING
Shelving MS Pro 200/150x60/4	1996	1612	603	4	Set of tiers MS Pro 200x60 - 2 pcs. Set of stands Profi 200 - 2 pcs. Beam MS Pro 150 Z - 8 pcs. Level shelf MS Pro 60x15 Z - 40 pcs.
Shelving MS Pro 200/150x80/4	1996	1612	803	4	Set of tiers MS Pro 200x80 - 2 pcs. Set of stands Profi 200 - 2 pcs. Beam MS Pro 150 Z - 8 pcs. Level shelf MS Pro 80x15 Z - 40 pcs.
Shelving MS Pro 200/180x60/4	1996	1912	603	4	Set of tiers MS Pro 200x60 - 2 pcs. Set of stands Profi 200 - 2 pcs. Beam MS Pro 180 Z - 8 pcs. Level shelf MS Pro 60x15 Z - 48 pcs.
Shelving MS Pro 250/180x60/4	2496	1912	603	4	Set of tiers MS Pro 250x60 - 2 pcs. Set of stands Profi 250 - 2 pcs. Beam MS Pro 180 Z - 8 pcs. Level shelf MS Pro 80x15 Z - 48 pcs.
Shelving MS Pro 250/150x80/5	2496	1612	803	5	Set of tiers MS Pro 250x80 - 2 pcs. Set of stands Profi 250 - 2 pcs. Beam MS Pro 150 Z - 10 pcs. Level shelf MS Pro 80x15 Z - 50 pcs.
Shelving MS Pro 250/150x60/5	2496	1612	603	5	Set of tiers MS Pro 250x60 - 2 pcs. Set of stands Profi 250 - 2 pcs. Beam MS Pro 150 Z - 10 pcs. Level shelf MS Pro 60x15 Z - 50 pcs.
Shelving MS Pro 300/150x60/5	2996	1612	603	5	Set of tiers MS Pro 300x60 - 2 pcs. Set of stands Profi 300 - 2 pcs. Beam MS Pro 150 Z - 10 pcs. Level shelf MS Pro 60x15 Z - 50 pcs.
Shelving MS Pro 300/150x80/5	2996	1612	803	5	Set of tiers MS Pro 300x80 - 2 pcs. Set of stands Profi 300 - 2 pcs. Beam MS Pro 150 Z - 10 pcs. Level shelf MS Pro 80x15 Z - 50 pcs.
Additional shelving for common rack MS Pro 200/150x60/4	1996	1580	603	4	Set of tiers MS Pro 200x60 - 1 pcs. Set of stands Profi 200 - 1 pcs. Beam MS Pro 150 Z - 8 pcs. Level shelf MS Pro 60x15 Z - 40 pcs.
Additional shelving for common rack MS Pro 200/150x80/4	1996	1580	803	4	Set of tiers MS Pro 200x80 - 1 pcs. Set of stands Profi 200 - 1 pcs. Beam MS Pro 150 Z - 8 pcs. Level shelf MS Pro 80x15 Z - 40 pcs.
Additional shelving for common rack MS Pro 200/180x60/4	1996	1880	603	4	Set of tiers MS Pro 200x60 - 1 pcs. Set of stands Profi 200 - 1 pcs. Beam MS Pro 180 Z - 8 pcs. Level shelf MS Pro 60x15 Z - 48 pcs.
Additional shelving for common rack MS Pro 250/180x60/4	2496	1880	603	4	Set of tiers MS Pro 250x60 - 1 pcs. Set of stands Profi 250 - 1 pcs. Beam MS Pro 180 Z - 8 pcs. Level shelf MS Pro 80x15 Z - 48 pcs.
Additional shelving for common rack MS Pro 250/150x80/5	2496	1580	803	5	Set of tiers MS Pro 250x80 - 1 pcs. Set of stands Profi 250 - 1 pcs. Beam MS Pro 150 Z - 10 pcs. Level shelf MS Pro 80x15 Z - 50 pcs.
Additional shelving for common rack MS Pro 250/150x60/5	2496	1580	603	5	Set of tiers MS Pro 250x60 - 1 pcs. Set of stands Profi 250 - 1 pcs. Beam MS Pro 150 Z - 10 pcs. Level shelf MS Pro 60x15 Z - 50 pcs.
Additional shelving for common rack MS Pro 300/150x60/5	2996	1580	603	5	Set of tiers MS Pro 300x60 - 1 pcs. Set of stands Profi 300 - 1 pcs. Beam MS Pro 150 Z - 10 pcs. Level shelf MS Pro 60x15 Z - pcs.
Additional shelving for common rack MS Pro 300/150x80/5	2996	1580	803	5	Set of tiers MS Pro 300x80 - 1 pcs. Set of stands Profi 300 - 1 pcs. Beam MS Pro 150 Z - 10 pcs. Level shelf MS Pro 80x15 Z - 50 pcs.

Storage options for car tires and wheels

Tire cover



Tire cover is installed on the level beams for rounding the corners of beams.



MS Pro 200/150/300/4



MS Pro 200/150/600/3



MS Pro 200/150x60/3

Shelving / Level Capacity

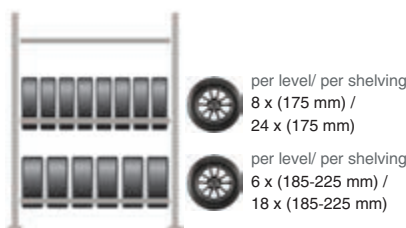

per level/ per shelving
8 x (175 mm) /
24 x (175 mm)

per level/ per shelving
6 x (185-225 mm) /
18 x (185-225 mm)

MS Pro 200/150/60

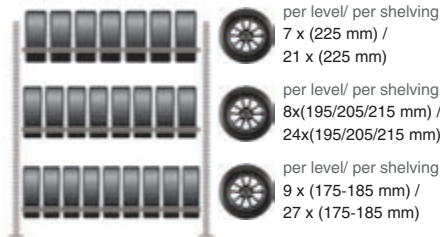

per level/ per shelving
7 x (225 mm) /
21 x (225 mm)

per level/ per shelving
8x(195/205/215 mm) /
24x(195/205/215 mm)

per level/ per shelving
9 x (175-185 mm) /
27 x (175-185 mm)

MS Pro 200/180/60

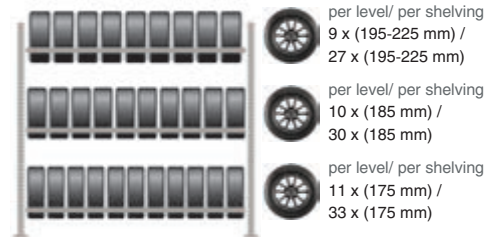

per level/ per shelving
9 x (195-225 mm) /
27 x (195-225 mm)

per level/ per shelving
10 x (185 mm) /
30 x (185 mm)

per level/ per shelving
11 x (175 mm) /
33 x (175 mm)

MS Pro 200/210/60

MODEL	WIDTH, MM	DEPTH, MM	PIKING
Tire level MS Pro 150x60	1500	600	In addition to standard level MS Pro in addition should be purchased: tire cover MS Pro 150 - 2 pcs., level shelves are not installed
Tire level MS Pro 180x60	1800	600	In addition to standard level MS Pro in addition should be purchased: tire cover MS Pro 180 - 2 pcs., level shelves are not installed
Tire level MS Pro 210x60	2100	600	In addition to standard level MS Pro in addition should be purchased: tire cover MS Pro 210 - 2 pcs., level shelves are not installed

Due to the common frame, an unlimited number of additional shelving can be attached to the main shelving with the help of hooks. Each additional shelving consists of one completed frame and the required number of tiers. The max load per shelving is not reduced in this case.



Options for shelving **MS**

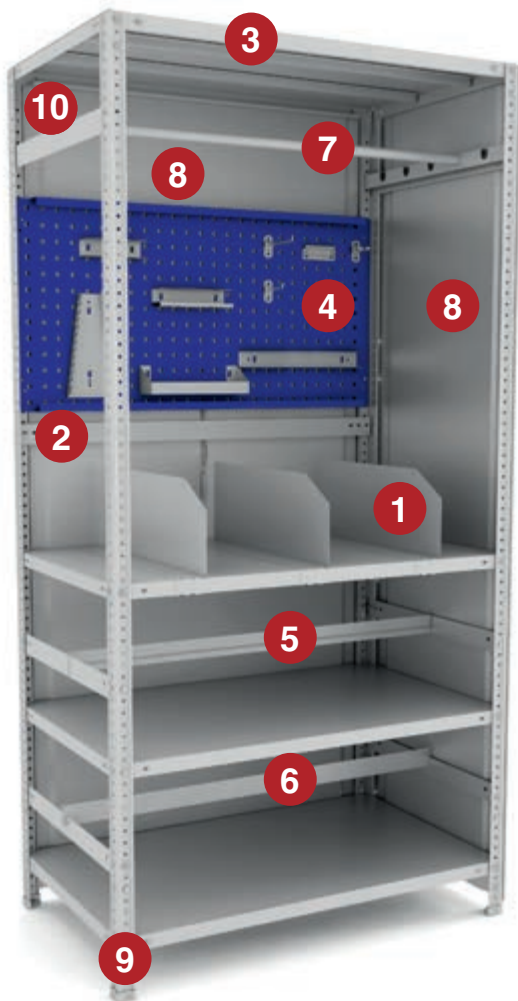

Perforated panel WS-100/WS-120 used for shelving with width of 1000 and 1200 mm

For accessories please see p. 32

4



Longitudinal 5 divider MSP

5

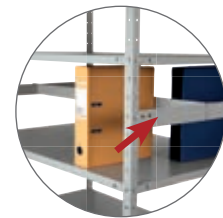

Set of dividers MS CR

6

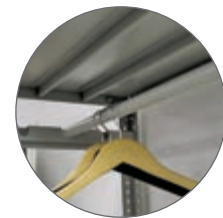

Crossbar for hangers (set)

7



Divider MS

1

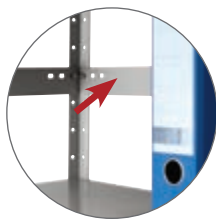

Limiter bar MS

2



Additional shelf stiffener MS (2 pcs. per shelf)

3



Back and side walls MS

8



* Steel saddle + high adjustment screw

** Only for MS Strong and MS HARD

9



Set of L-type strengtheners

10

Options for shelving **MS**

MODEL	HEIGHT, mm	WIDTH, mm	DEPTH, mm
Stand MS Standart – 160*/185/200/220/255	1600/1850/2000/2200/2550	30	30
Stand MS Strong – 160*/185/200/220/235*/255/275*/310	1850/2000/2200/2350/2550/2750/3100	38	38
Stand MS Hard 1000 – 185*/200/220/250/300	1850/2000/2200/2500/3000	40	40
Shelf MS Standart – 70x30/40/50/60	33	698	298/398/598/598
Shelf MS Standart – 100x25/30/40/50/60	33	998	248/298/398/598/598
Shelf MS Strong – 70x30/40/50/60/70/80	40	698	298/398/598/598/698/798
Shelf MS Strong – 100x30/40/50/60/70/80	40	998	298/398/598/598/698/798
Shelf MS Strong – 120x30/40/50/60/70/80	40	1198	298/398/598/598/698/798
Shelf MS Strong – 150x30/40/50/60	40	1498	298/398/598/598
Shelf MS Hard – 100x30/40/50/60	33	998	298/398/598/598
① Divider MS-30/40/50/60			300/400/500/600
② Limiter bar MS-25/30/40/50/60			250/300/400/500/600
② Limiter bar MS-70/100/120			700/1000/1200
③ Additional shelf stiffener MS-70/100/120		700/1000/1200	
④ Perforated panel WS-100/WS-120	500	1000/1200	1.2
⑤ Longitudinal divider MSP 70/2; MSP 100/2; MSP 120/2		720/1000/1020	50/50/50
⑥ Set of dividers MS CR 70x60 / MS CR 100x60**		700/1000	600/600
⑦ Crossbar for hangers (set) MS 100x60		1000	600
⑧ Side wall MS 50x25/30/40/50/60	500		300/400/500/600
⑧ Side wall MS 200x25/30/40/50/60	2000		300/400/500/600
⑧ Back wall MS 50x70/100/120	500	700/1000/1200	
⑧ Back wall MS 200x70/100/120	2000	700/1000/1200	
⑨ Steel saddle + hight adjustment screw MS Strong and MS HARD			
⑩ Set of L-type strenghteners MS (8 pcs.)			

* On request. MOQ - 100 pcs.; ** Purchasing pos. ② is a must.



Shelves and stands are compatible in all configuration MS Standart, MS Strong, MS Hard), but it is recommended to use shelves and stands of the same series; stiffeners are suitable for all types of shelves MS series (Standart, Strong, Hard).

DIFFERENT NEEDS – ONE SOLUTION



Office



Storage room



Archive



Warehouse





Garage



Medical institutions

MIDDLE-LOAD SHELVING **SB**

Designed for storing heavy loads and bulky goods. Used to equip warehouses, trading halls, production workshops, car services and personal garages for long-term and short-term storage of various items.

● **Colour:**  RAL 7038  RAL 5002

- Easy assembling structure
- Plywood, steel, net-type shelves
- Fast and easy assembly

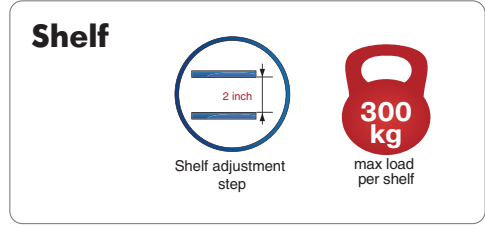
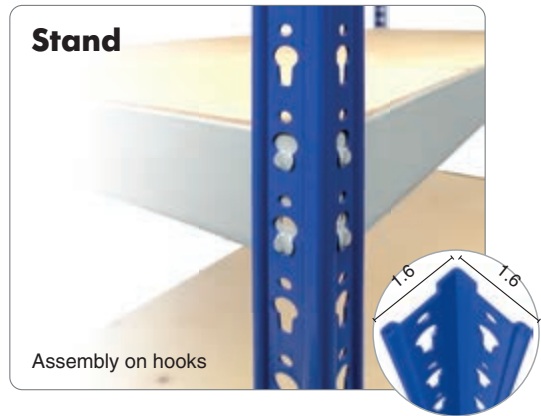

Beam SB



Beam SB 51
Beam SB 61
Beam SB 76
Beam SB 91
Beam SB 152
Beam SB 183

Stand SB



StandSB 200
Stand SB 260
Stand SB 300

Plywood shelf SB



Shelf SB 152x51/61/76/91
Shelf SB 183x51/61/76/91

STANDARD SET **SB** OPTIONS

3 shelves



SB 200x152x61/3

4 shelves



SB 200x183x51/4

5 shelves



SB 250x183x76/5

6 shelves



SB 300x183x91/6

Standard sets

NAME	DIMENSIONS HxWxD, mm	NUMBER OF SHELVES	WEIGHT, kg
SHELVING SB 200 X 152 X 51/4	2000 X 1525 X 508	4	47
SHELVING SB 200 X 152 X 61/4	2000 X 1525 X 610	4	53
SHELVING SB 200 X 152 X 61/5	2000 X 1525 X 610	5	64
SHELVING SB 200 X 183 X 61/4	2000 X 1830 X 610	4	60
SHELVING SB 200 X 183 X 76/4	2000 X 1830 X 760	4	69
SHELVING SB 250 X 152 X 51/4	2500 X 1525 X 508	4	49
SHELVING SB 250 X 152 X 61/4	2500 X 1525 X 610	4	55
SHELVING SB 250 X 152 X 91/5	2500 X 1525 X 914	5	85
SHELVING SB 250 X 183 X 61/4	2500 X 1830 X 610	4	62
SHELVING SB 300 X 152 X 76/5	3000 X 1525 X 760	5	77
SHELVING SB 300 X 183 X 61/6	3000 X 1830 X 610	6	90



STEEL SHELVING SBL

Universal shelving for use at home, office and workshop

- **Colour:**  RAL 7016 moire
- 5 adjustable levels. Fiberboard shelves or steel shelves
- 0,8 mm KD stand
- Rivet type joints of beams and stands
- Possibility to assemble different varieties of shelving (in height or in width)



Option 1

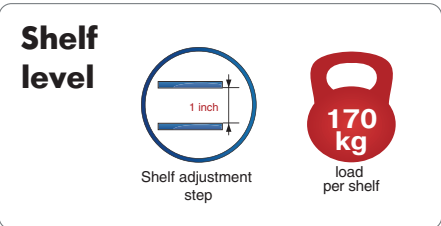

Option 2

Shelving sets SBL

NAME	DIMENSIONS, MM			NUMBER OF SHELVES	SET
	HEIGHT	WIDTH	DEPTH		
Shelving SBL 180KD/75x35/5	1803	751	351	5	Stand SBL – 8 pcs. Stand connector SBL – 4 pcs. Front beam SBL – 10 pcs. Side beam SBL – 10 pcs. Beam screed SBL – 5 pcs. Fiberboard shelf – 5 pcs. Plastic saddle – 8 pcs.
Shelving SBL 180KD/90x40/5	1803	901	401	5	
Shelving SBL 180KD/90x45/5	1803	901	451	5	
Shelving SBL 180KD/120x40/5	1803	1201	401	5	
Shelving SBL 180KD/120x45/5	1803	1201	451	5	

STANDARD SET **SBL** OPTIONS

2 ASSEMBLY OPTIONS



Shelving sets SBL

NAME	DIMENSIONS, mm			NUMBER OF SHELVES	SET	PACKAGE DIMENSIONS
	HEIGHT	WIDTH	DEPTH			
Shelving SBL 180KD/75x35/5	1803	751	351	5	Stand SBL – 8 pcs. Stand connector SBL – 4 pcs. Front beam SBL – 10 pcs. Side beam SBL – 10 pcs. Beam screed SBL – 5 pcs. Fiberboard cover – 5 pcs. Plastic saddle – 8 pcs.	910x360x65
Shelving SBL 180KD/90x40/5	1803	901	401	5		910x430x65
Shelving SBL 180KD/90x45/5	1803	901	451	5		910x370x75
Shelving SBL 180KD/120x40/5	1803	1201	401	5		1200x425x75
Shelving SBL 180KD/120x45/5	1803	1201	451	5		1200x470x75



Stands and beams could be made of galvanized steel



COMPACT PACKAGE
FITS CAR TRUNK

MODULAR LOCKER SYSTEM **ML**

Designed for storing clothes, personal belongings, inventory in industrial, sports and other premises, as well as for installation at storage rooms.

● **Colour:**  RAL 7038

Advantages of the new technology

- **Stable and rigid body.**
The design is based on a welded frame, which provides the correct geometry and strength to the body. Together with other design solutions, it provides excellent strength and stability of the locker, comparable to welded structures.
- **Modular system: The system consists of base module and additional modules (unlimited lockers in line).**
Special elements such as common side wall allows to build up a number of modules of any length, depending on the characteristics of the room. 5 combination of models. Lockers are equipped with shelves, crossbar, hooks for clothes. Optionally can be added: shoe shelves, 2 types of partitions to separate clean clothes and workwear.



RIGID BODY

The body is reinforced with the welded frame



KEY LOCK

2000 combinations



FAST VERTICAL ASSEMBLY

The ability to assemble in narrow spaces. Mounting system «hooks» makes the assembly fast and easy



MODULAR SYSTEM

Possibility to assemble any combination of models due to the common wall and special elements of the side mounts



IMPROVED VENTILATION

Ventilation holes in doors and back wall



ANY DOOR OPENING SIDE

Door opening side can be changed

Range of use



CHANGING ROOMS



PRIVATE BELONGING STORAGE



STORAGE OF BAGS AND SUITCASES

Additional colours

Standard colour

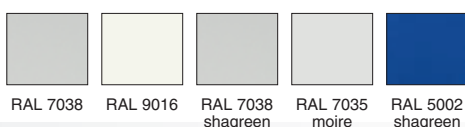

Non-standard colour



PERSONAL LOCKERS (REINFORCED) **ML**



ML 11-30



ML 11-40



ML 01-40

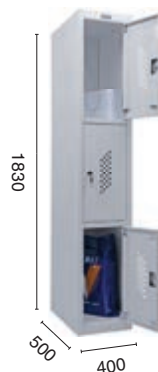

ML 13-30



ML 03-30

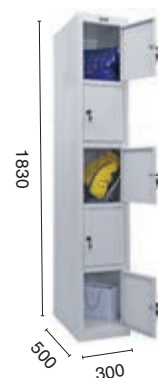

ML 15-30

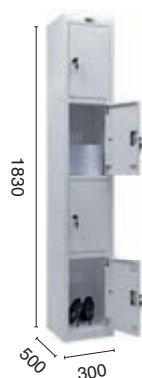

ML 14-30-30



ML 04-30-30



ML 11-50



Door hooks

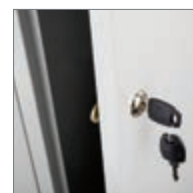

Key lock



Ventilation



Crossbars, hooks

+ OPTIONS

Stand ML

Made of square tubes 20x20 mm, with adjustable legs.



Plynth ML

galvanized steel



Vertical partition ML 1200/ ML 1500

Vertical partition ML 1200 – installed between top shelf and lower shelf for separation of «clean» and «work» clothes.

Vertical partition ML 1500 – Installed between top shelf and the bottom of the locker or separation of «clean» and «work» clothes.



Key lock PL

Keyless lock Euro-locks A129 with a device for the padlock.



Padlock bracket

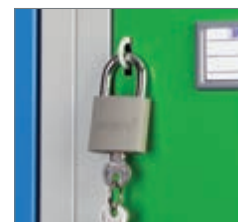

PLAN FILES **A1** & **A0**

Designed for convenient storage of A1 and A0 format documents (maps, design documentation, plans, drawings).

- **Colour:**  RAL 7038
- Ball bearing slides ensure free and smooth running of drawers even when fully loaded.
- Drawers full extension system.
- 5 drawer plan files are manufactured. Models 05\1, 05\2, 05\3 can be stacked together to create 10 or 15 drawers plan file.
- All drawers equipped with a pressure bar to prevent creasing and dividers for storing documents of smaller formats.
- Central key lock on each module.
- Delivered assembled.



Ball bearing slides

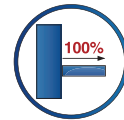

Full drawer extension



Central Key Lock



20 kg
Max load per drawer



3 modules plan file

Drawer dimensions, H x W x D, mm:

A1-05: 48x908x660

A0-05: 44x1280x910

A0-05/0; A1-05/0

Separate module with roof and legs

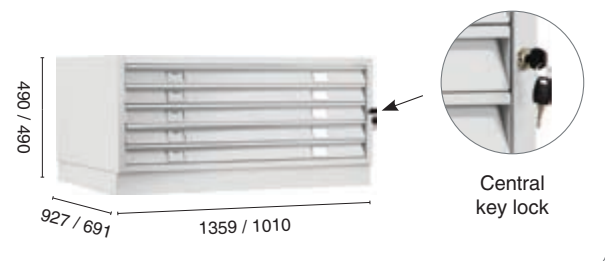

A0-05/1; A1-05/1

Top module with roof (no basement)

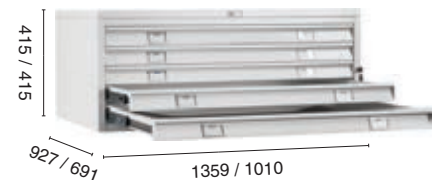

A0-05/2; A1-05/2

Middle module (no basement and roof)

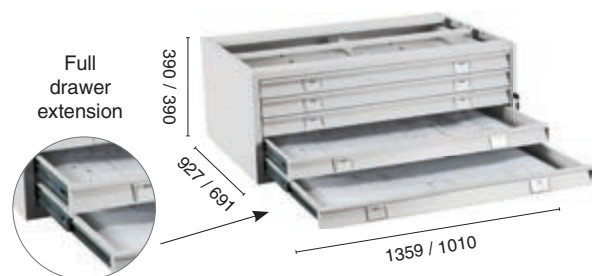

A0-05/3; A1-05/3

Bottom module (with basement, no roof)

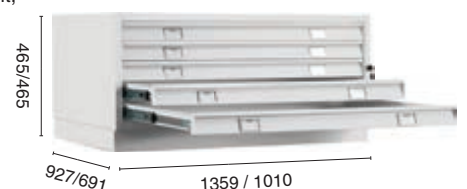

2 dividers (included)



Pressure bar (included)

PROJECTS SAMPLES

Customer: City transport repair workshop

City: St. Petersburg



PROJECTS SAMPLES

Customer: Military investigation laboratory



Customer: Customer: Business park - University (Classrooms)

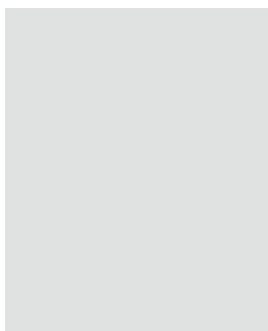

PROJECTS SAMPLES

Customer: Governmental College of professional and technical Knowledge. Classrooms



Customer: City government. Repair workshop.

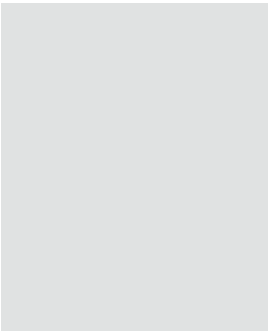

USEFUL INFORMATION

Article number	Name	Package dimensions H x W x D, mm	Gross weight, kg	Volume	Q-ty in package	Q-ty of boxes
WORKBENCHES PROFI W						
S30299010458	Tabletop Profi WT-100	1020x705x37	20,1	0,026	1	1
S30299020146	Pedestal Profi WD-1	865x660x470	24,3	0,027	1	1
S30299080102	Leg Profi WF-1	865x670x90	5	0,052	1	1
S30299067202	Shelf and wall Profi WSh-160/2	645x570x50	4,95	0,018	1	1
S30299067102	Shelf and wall Profi WSh-160/1	1005x565x45	7,1	0,026	1	1
S30299066102	Shelf and wall Profi WSh-140/1	805x570x50	6,1	0,023	1	1
S30299065102	Shelf and wall Profi WSh-120/1	605x570x50	4,7	0,0173	1	1
S30299020546	Pedestal Profi WD-5	865x660x470	44	0,27	1	1
S30299010758	Tabletop Profi WT-160	1620x710x40	36,6	0,046	1	1
S30299010658	Tabletop Profi WT-140	1420x705x37	30	0,037	1	1
S30299010558	Tabletop Profi WT-120	1220x705x37	25,95	0,031	1	1
S30299020246	Pedestal Profi WD-2	865x660x470	30,2	0,27	1	1
S30299065002	Shelf and wall Profi WSh-120/0	950x570x50	7,25	0,027	1	1
S30299068202	Shelf and wall Profi WSh-180/2	850x570x50	6,1	0,024	1	1
S30299010858	Tabletop Profi WT-180	1820x705x37	40,3	0,047	1	1
S30299020646	Drawer Profi WD-0	660x485x300	18,25	0,096	1	1
WORKBENCHES EXPERT T						
S30299011558	Tabletop Expert W-120	1220x705x35	18,2	0,30	1	1
S30299011458	Tabletop Expert W-150	1520x705x35	23,62	0,037	1	1
S30299011758	Tabletop Expert W-160	1620x705x35	24	0,039	1	1
S30299011958	Tabletop Expert W-200	2020x705x35	31	0,049	1	1
S30299011999	Cover Expert for W-200	2020x705x35	53,9	0,049	1	1
S30299012558	Tabletop Expert WTS-120	1220x705x35	27,8	0,03	1	1
S30299012458	Tabletop Expert WTS-150	1520x705x35	37,46	0,039	1	1
S30299012758	Tabletop Expert WTS-160	1620x705x35	38,2	0,04	1	1
S30299012958	Tabletop Expert WTS-200	2020x705x35	47,9	0,05	1	1
S30299013558	Tabletop Expert WTH-120	1220x705x35	38,9	0,03	1	1
S30299013458	Tabletop Expert WTH-150	1520x705x35	51,5	0,039	1	1
S30299013758	Tabletop Expert WTH-160	1620x705x35	52,3	0,04	1	1
S30299013958	Tabletop Expert WTH-200	2020x705x35	65	0,05	1	1
S30299922114	Pedestal Expert T-1	835x610x680	46	0,035	1	1
S30299922414	Pedestal Expert T-6	835x610x680	78	0,035	1	1
S30499842041	Light set Profi M	1440x226x80	12	0,026	1	1
S30499843014	Set of triangles Profi M	500x180x40	3,5	0,004	1	1
S30499844041	Brackets Profi M (2 pcs.)	1000x40x40	3	0,002	1	1
WORKBENCHES PROFI M						
S30299822114	Pedestal Profi M-1	860x590x610	35	0,31	1	1
S30299822414	Pedestal Profi M-4	860x590x610	52	0,31	1	1
S30299822514	Pedestal Profi M-5	860x590x610	56	0,31	1	1
S30499819301	Tabletop Profi MTS-160	1610x710x30	24,2	0,034	1	1
S30499819341	Tabletop Profi MTH-160	1610x710x30	26,6	0,034	1	1
S30499819501	Tabletop Profi MTS-200	2010x710x30	27,8	0,03	1	1
S30499819541	Tabletop Profi MTH-200	2010x710x30	37,46	0,039	1	1
S30499821000	Leg Profi M	880x660x70	12,5	0,041	1	1
S30499833141	Shelf and wall Profi M-160/1	409x966x27	7	0,018	1	1
S30499833241	Shelf and wall Profi M-160/2	410x1386x27	2	0,020	1	1
S30499835141	Shelf and wall Profi M-200/1	410x941x27	9	0,031	1	1
S30499835241	Shelf and wall Profi M-200/2	1620x705x35	8	0,029	1	1
S30499841214	Perforated panel Profi M-150	1510x510x45	8,5	0,040	1	1
S30499841314	Perforated panel Profi M-160	1610x510x45	9,5	0,041	1	1
S30499841514	Perforated panel Profi M-200	2010x510x45	12,5	0,046	1	1
S30499842041	Light set Profi M	1440x226x80	12	0,026	1	1
S30499843014	Set of triangles Profi M	500x180x40	3,5	0,004	1	1
S30499844041	Brackets Profi M (2 pcs.)	1000x40x40	3	0,002	1	1
WORKBENCHES MASTER						
S30399500646	Workbench Master №106	115x1020x53	36,6	0,044	1	1
S30299080002	Leg Master MF-1	65x838x85	4,2	0,005	1	1
S30299091302	Shelf Master M-100	40x870x400	4,3	0,014	1	1
S30299091102	Beam Master M-90	65x1000x140	1,6	0,003	3	1
S30399500146	Workbench Master №101	80x1020x530	29,1	0,043	1	1
S30399500246	Workbench Master №102	80x1020x535	23,3	0,044	1	1
S30399500446	Workbench Master №104	120x1020x535	38,7	0,044	1	1
S30399500346	Workbench Master №103	100x1050x510	34,9	0,053	1	1
S30299014058	Tabletop Master MT-100	30x1020x510	14,9	0,015	1	1
S30299091402	Drawer Master M-140	140x860x390	6,7	0,047	1	1
S30299014458	Tabletop Master M-100	30x1020x510	8,5	0,015	1	1
WORKBENCHES GARAGE						
S30399500946	Drawer Garage	490x420x65	3	0,014	1	1
S30399500846	Workbench Garage №112	1010x515x110	22,5	0,06	1	1
S30399501646	Workbench Garage Set 2	140x1140x560	35	0,089	1	1
S30399501546	Workbench Garage Set 1	140x1140x560	29	0,089	1	1
S30399520146	Tool trolley Garage	130x930x510	19,6	0,062	1	1
S30399520246	Drawer for tool trolley Garage	90x640x520	5,1	0,029	1	1
S30399521107	Set of side perforated panels Garage MS (2 pcs.)	515x415x45	3	0,01	1	1

USEFUL INFORMATION

Article	Name Package	Package dimensions H x W x D, mm	Gross weight,kg	Volume	Q-ty in package	Q-ty of boxes
TOOL TROLLEYS WDS						
S30299026546	Tool trolley HARD SK 50 shelf	725x175x95	1,9	0,011	1	1
S30299025846	Tool trolley WDS-HARD	855x600x95	26,1	0,046	1	1
S30299025046	Tool trolley WDS-0	855x620x125	17,3	0,066	1	1
S30299025946	Tool trolley WDS-9	1040x630x540	67	0,35	1	1
S30299026346	Tool trolley HARD Shelf	40X700x450	4,3	0,012	1	1
S30299026602	Tool trolley HARD HSK 63 shelf	30x710x150	1,9	0,003	1	1
S30299040107	Perforated panel WDS	32x756x510	4,8	0,015	1	1
S30299026102	Set of dividers WDS	81,5x660x385	3,5	0,001	1	1
S30299026446	Tool trolley HARD SK 40 shelf	725x175x70	1,9	0,0088	1	1
S30299022314	Tool trolley WDS-3.0 new	1) 780x760x500 2) 880x560x85	1) 58 2) 3,85	1) 0,3 2) 0,042	1	2
S30299022514	Tool trolley WDS-5.0 new	1) 780x760x500 2) 880x560x85	1) 61,5 2) 3,85	1) 0,3 2) 0,042	1	2
S30299022614	Tool trolley WDS-6.0 new	1) 780x760x500 2) 880x560x85	1) 62,5 2) 3,85	1) 0,3 2) 0,042	1	2
S30299022914	Tool trolley WDS-9.0 new	1) 780x760x500 2) 880x560x85	1) 66,5 2) 3,85	1) 0,3 2) 0,042	1	2
S30299023614	Tool trolley WDS-6.1 new	1)1160x760x570 2)1180x560x80	1)69.5 2)4.6	1)0.5 2)0.05	1	2
S30299023514	Tool trolley WDS-5.1 new	1)1160x760x570 2)1180x560x80	1)67.5 2)4.6	1)0.5 2)0.05	1	2
S30299023914	Tool trolley WDS-9.1 new	1)1160x760x570 2)1180x560x80	1)83 2)4.6	1)0.5 2)0.05	1	2
S30299033504	Tool trolley WDS D-5.0	960x510x170	43	0,083	1	1
S30299033514	Tool trolley WDS D-5.1	880x510x180	46	0,081	1	1
S30299033604	Tool trolley WDS D-6.0	960x510x170	44	0,083	1	1
S30299033614	Tool trolley WDS D-6.1	880x510x180	47	0,081	1	1
TOOL CABINET TC 1095/TC 1995						
S30599025107	TC perforated panel TCS 50x43	505x445x25	2,5	0,003	2	1
S30599022202	TC large shelf TCSH 95x47	960x450x110	3,9	0,0118	4	1
S30599023246	TC large drawer TCF 87x45	1015x460x50	7	0,023	1	1
S30599021202	TC vertical partition TCD-1800	1805x490x40	8,1	0,035	1	1
S30599015046	TC tool cabinet TC-1995	1935x542x170	54,7	0,178	1	1
S30599023146	TC small drawer TCF 42x45	575x460x50	4,8	0,014	1	1
S30599012046	TC tool cabinet TC-1095	1030x535x160	34,6	0,093	1	1
S30599022102	TC small shelf TCSH 43x47	490x460x110	1,9	0,006	1	1
S30599021302	TC vertical partition TCD-1800/2	950x490x60	6,5	0,022	1	1
S30599021102	TC vertical partition TCD-900	950x490x40	4,6	0,019	1	1
S30599025002	TC CNC shelf SK-50	115x890x190	10,5	0,02	1	1
S30599013046	TC tool cabinet TC-1947	1935x550x140	35,7	0,149	1	1
S30599014046	TC tool cabinet TC-1995/2	1935x550x140	53,2	0,149	1	1
S30599023346	TC drawer TCF 39x45	550x450x40	4,5	0,01	1	1
S30599022112	TC wardrobe set TCSH	475x435x30	2	0,0062	1	1
HEAVY DUTY TOOL CABINET AMH TC						
S30699015446	Tool cabinet AMH TC EL	1885x940x550	116,2	0,82	1	1
S30699022702	Set of shelves AMH TC SK 50 (2pcs.)	90x840x180	3,75	0,015	1	1
S30699022602	Set of shelves AMH TC SK 40 (2pcs.)	90x840x180	3,75	0,015	1	1
S30699025107	Set of perforated panels AMH TC (2 pcs.)	20x850x160	2,2	0,006	1	1
S30699023246	Drawer AMH TC 125	135x850x410	7,49	0,016	1	1
S30699023146	Drawer AMH TC 60	70x850x410	5,4	0,014	1	1
S30699022202	Shelf AMH TC	30x850x400	6,48	0,01	1	1
S30699023602	Set of dividers K AMH TC 60/125	25x824x48	1,5	0,001	1	1
S30699015046	Tool cabinet AMH TC	1885x940x550	116,2	0,82	1	1
S30699022802	Set of shelves AMH TC HSK 63 (2pcs.)	90x840x180	3,75	0,015	1	1
HEAVY DUTY MODULAR TOOL CABINETS HARD						
S30599664246	Drawer HARD 125	1235x535x60	14,2	0,04	1	1
S30599660146	Cabinet body HARD 1000	80x1030x570 160x1105x600	23.1 32.3	0,047 0,106	1	2
S30599663146	Shelf HARD	1050x610x50	14,6	0,032	1	1
S30599661646	Set of dividers HARD 60	1010x65x10	3,7	0,001	1	1
S30599664146	Drawer HARD 60	1050x550x50	14,6	0,029	1	1
S30599664346	Drawer HARD 265	1535x550x50	20,8	0,0533	1	1
S30599661346	Frame HARD 2000	100x600x2000	11,95	0,0124	1	1
S30599661146	Frame HARD 1000	100x600x1000	7,31	0,006	1	1
S30599661746	Set of dividers HARD 125	975x130x15	6,6	0,0025	1	1
S30599660346	Cabinet body HARD 2000	70x2035x590 185x1110x610	43.4 40.3	0,084 0,125	1	2
S30599666146	CNC shelf HARD SK 40	1060x190x60	3,7	0,012	1	1
S30599665146	Perforated panel HARD	1050x160x40	1,95	0,007	1	1
S30599666246	CNC shelf HARD SK 50	1060x190x80	3,8	0,016	1	1
S30599666302	CNC shelf HARD HSK 63	30x710x150	1,9	0,003	1	1
S30599666500	Bracket for CNC shelves SK, HSK HARD (2 pcs.)	30x650x70	2,1	0,0014	1	1
S30599663346	Pull out shelf HARD	1080x560x50	13,4	0,0302	1	1
DRYING CABINETS DC						
S30799021002	Drying cabinet DC Breeze 1940 (No shelves)	160x1880x540 160x860x540	45,4 15,2	0,162 0,074	1	2
S30799011002	Drying cabinet DC Cyclone 1965	140x1950x600 160x660x630	48 15,4	0,164 0,066	1	2
S30799003100	Set of heat resistant trays DC Breeze 1940	25x390x430	1,9	0,004	1	1
S30799002100	Set of heat resistant trays DC Cyclone 1965	25x290x530	1,5	0,004	1	1
S30799001100	Set of heat resistant trays DC Cyclone 1985	25x390x530	2,7	0,005	1	1
S30799002002	Net-type shelf DC Cyclone 1965	10x310x540	0,5	0,002	4	1

USEFUL INFORMATION

Article	Name	Package dimensions HxWxD, mm	Gross weight, kg	Volume	Q-ty in package	Q-ty of boxes
S30799003002	Wire-type shelf 1940/1985	157x322x400	1,1	0,02	1	1
S30799001002	Net-type shelf DC Cyclone 1985	10x410x540	0,69	0,002	4	1
S30799015002	Drying cabinet DC Cyclone 1985	135x1975x620 170x885x675	55,5 16	0,165 0,102	1	2
S30799004002	Set DC 1940 (Shelves/ stand/ crossbar)	40x940x410	2,8	0,014	1	1
S30799038002	Drying cabinet DC Sakhara 8	1) 265x1885x640 2) 310x1880x670 3) 165x1850x665 4) 180x540x540	1) 79,5 2) 62 3) 38,7 4) 16,5	1) 0,32 2) 0,39 3) 0,20 4) 0,052	1	4
S30799035002	Drying cabinet DC Sakhara 5	1) 210x1885x605 2) 185x1885x750 3) 170x1575x680 4) 180x540x540	1) 60 2) 85,5 3) 44 4) 16,5	1) 0,239 2) 0,261 3) 0,182 4) 0,052	1	4
S30799051002	Drying stand NORTH 16	1) 250x1800x620 2) 190x990x640	1) 59 2) 45	1) 0,279 2) 0,12	1	2
S30799052002	Drying stand NORTH 20	1) 2090x655x220 2) 1400x530x190	1) 57 2) 51	1) 0,301 2) 0,141	1	2
PERFORATED PANELS, ACCESSORIES, OTHER						
S30299090002	Light set W	1270x100x55	5	0,094	1	1
S30299031907	Perforated panel WS-200	50x2030x530	13,7	0,052	1	1
S30299031807	Perforated panel WS-180	50x1830x530	11,3	0,048	1	1
S30299031707	Perforated panel WS-160	50x1630x530	9,8	0,043	1	1
S30299031607	Perforated panel WS-140	50x1430x530	8,5	0,037	1	1
S30299031507	Perforated panel WS-120	50x1230x530	7,4	0,033	1	1
S30299031407	Perforated panel WS-100	50x1030x530	6,4	0,027	1	1
S30299030007	Set of triangles for mounting perforated panels WS	45x505x210	2,2	0,005	1	1
S30299020846	Cabinet Profi WD	100x620x430	7,95	0,027	1	1
S30299030307	Perforated panel WS-60	30x620x610	2,85	0,011	1	1
S30299031002	Double perforated panels mounting bracket WS	24x1050x44	1,85	0,0012	1	1
S30299021800	Handle WS	35x515x70	0,5	0,001	1	1
S30299021900	Set WS (Rubber mat, tray, perforated panel)	30x665x615	9,7	0,0123	1	1
S30299090902	Set of wheels WS (4 pcs.)	130x340x290	10,2	0,012	1	1
S30299050407	Tool stand Frame	40x2060x500	8,7	0,04	1	1
HARDWARE PLASTIC BOXES						
S30299103007	Plastic box 400x230x150	240x505x495	0,59	0,059	10	1
S30299104007	Plastic box 170x80x105	85x175x110	0,2	0,002	10	1
S30299102007	Plastic box 400x185x100	100x400x185	0,54	0,007	10	1
S30299105007	Plastic box 200x157x90	350x250x175	0,016	0,002	10	1
CHAIRS						
S30299091200	Wheelchair Pro industrial	165x600x600	11	0,081	1	1
S30299091300	Industrial chair with armrest Pro industrial	220x600x600	13,2	0,094	1	1
S30299091100	Wheel stool Pro industrial	110x520x520	5,2	0,03	1	1
S30299105007	Plastic box 200x157x90	350x250x175	0,016	0,002	10	1

CNC instrument holder

Used for storing CNC instrument.

- Made of hard plastic
- Resistant to shocks, chips, the effects of motor oils, alcohols, gasoline and other liquids.
- Rigid fixation of the tool.

SK 40



Top D = 43,6 mm
Bottom D = 29,75 mm



SK 50



Top D = 69,7 mm
Bottom D = 49,4 mm



SK 63



Top D = 49 mm
Bottom D = 46,3 mm



PROMET

1991 ■

WORKBENCHES NAMING RULES

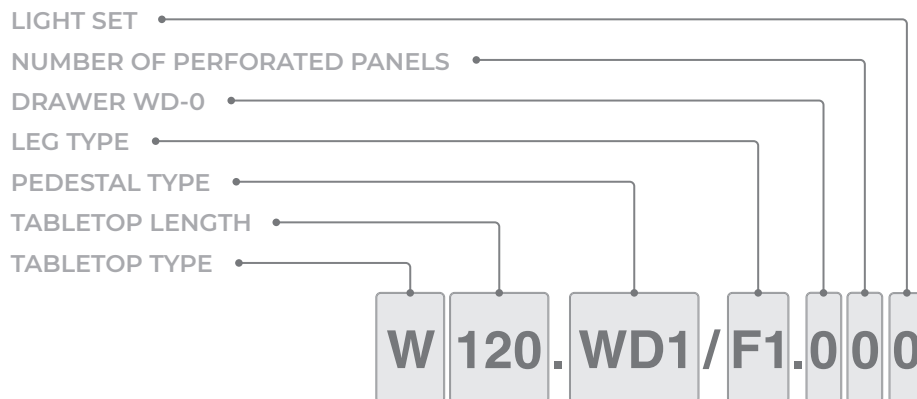

INDUSTRIAL CABINET NAMING RULES

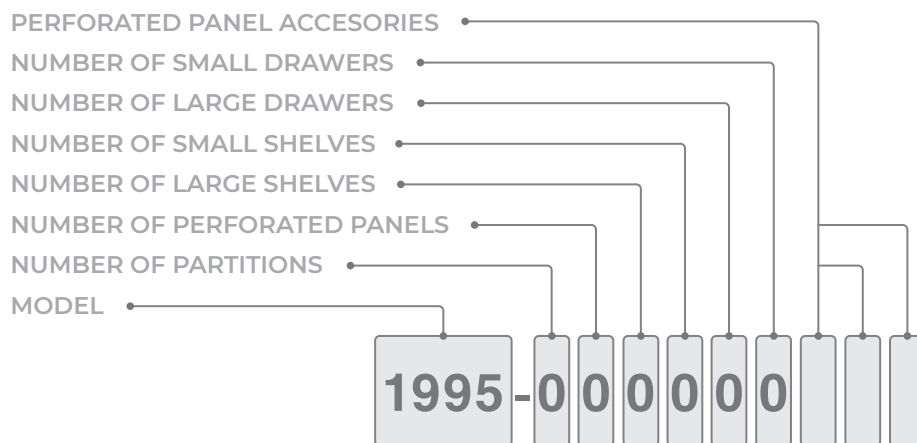

promet-safe.com

Up to 5 YEARS WARRANTY

Full After sales service

Contact you manager :